

FEATURES:

- All brass construction.
- Available in all Sigma finishes. Warranty varies according to finish selection.
- Mounting bracket and screws are supplied.

Series 82
Paper Holder
1.82PH00

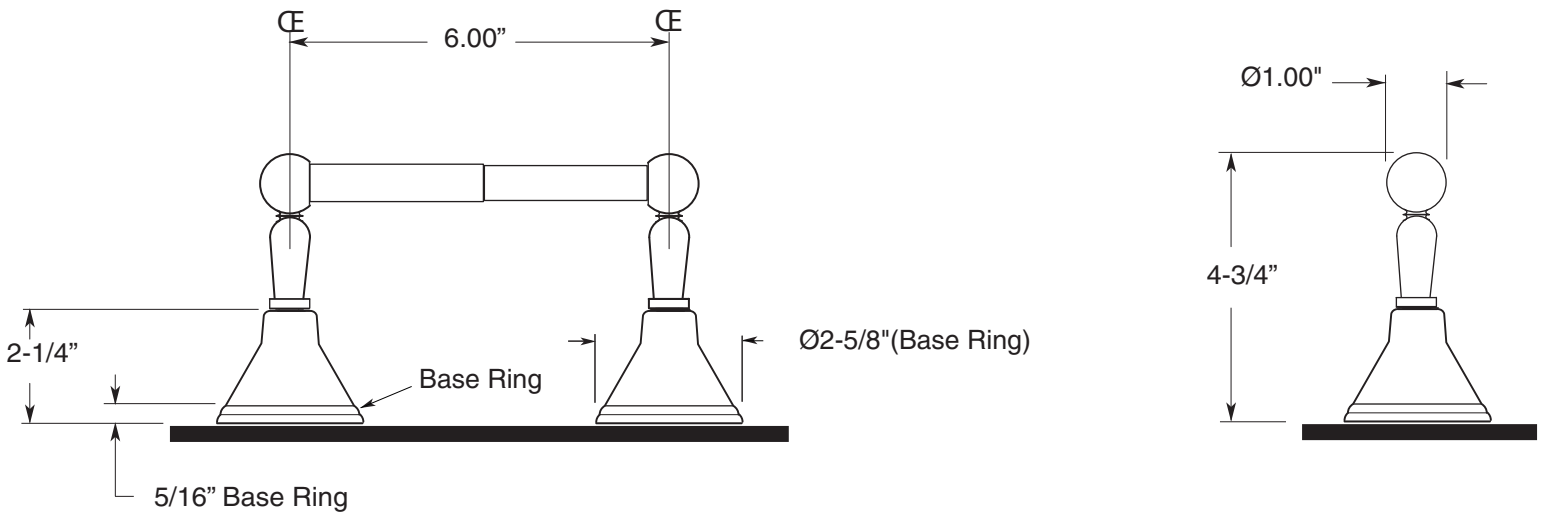

Note: Measurements are subject to change or cancellation. No responsibility is assumed for use of superseded or voided pages.