

FEATURES:

- All brass construction.
- Lever style handles with top screw attachment.
- 3/4" valve bodies with 1/4-turn ceramic disc cartridge.
- Available in all finishes. Warranty varies according to finish.
- Certified to meet or exceed the following codes and standards:
ASME A112.18.1/CSAB 125.1-2012

Regent
Roman Tub Set
1.285377
(1.285377T - Trim only)

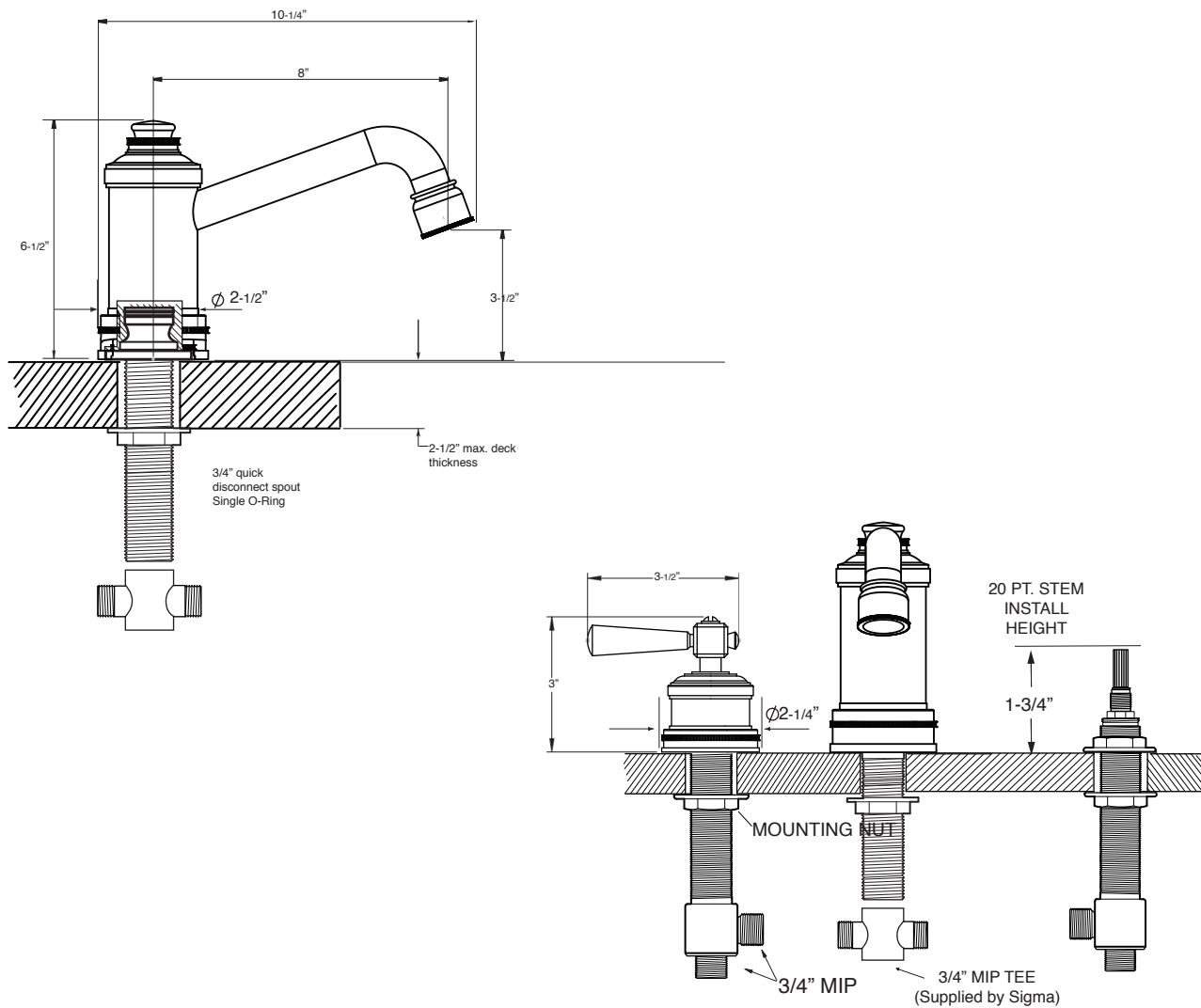

NOTE: Spout and valves install through 1-1/4" diameter holes.
Plumber to provide 3/4" supply lines to valves