

FEATURES:

- All brass construction.
- Cross handle style with center screw attachment.
- 3/4" valve bodies with 1/4-turn ceramic disc cartridge.
- Available in all finishes. Warranty varies according to finish.
- Certified to meet or exceed the following codes and standards:
ASME A112.18.1/CSAB 125.1-2011

Sussex
Roman Tub Set
1.157877
(1.157877T - Trim only)

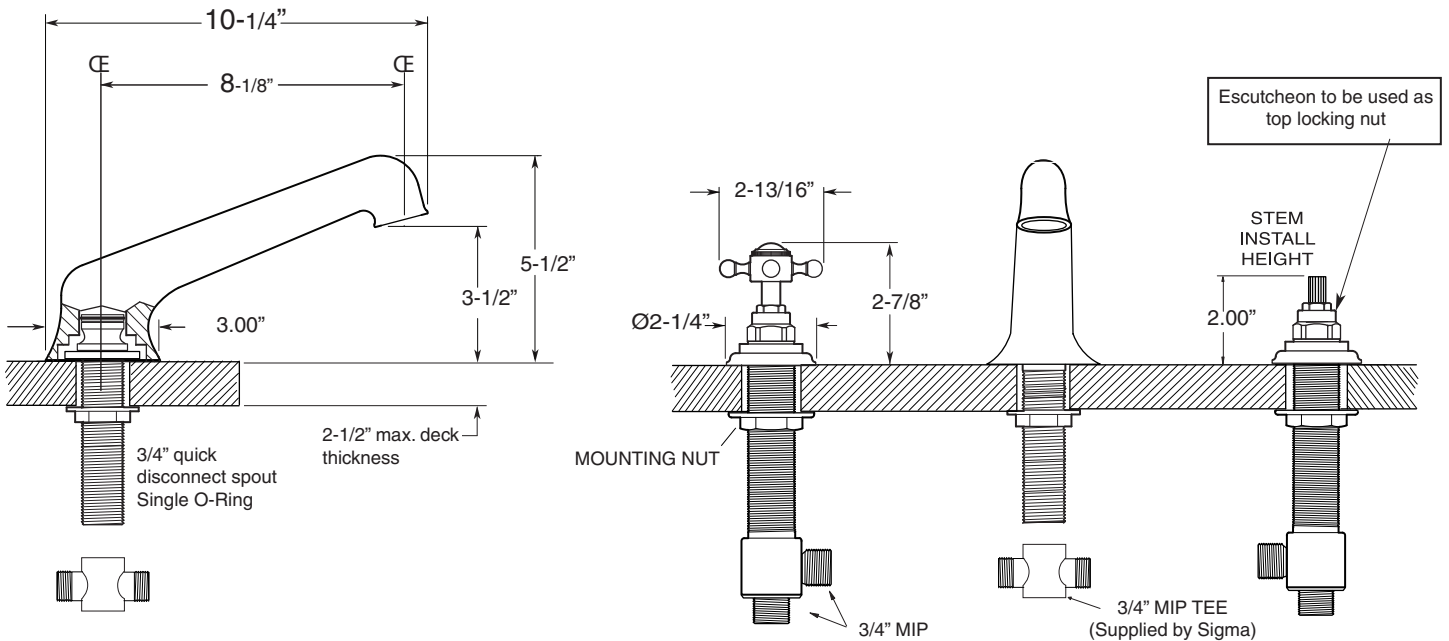

NOTE: Spout and valves install through 1-1/4" diameter holes.
Plumber to provide 3/4" supply lines to valves

Parts List Series 1500

Sussex Roman Tub Set

