

Features:

- Forged brass construction
- Valve cartridge 18.30.893
- Diverter Cartridge: 18.30.898
- Adjustable hot limit safety stop
- Reversible cartridge
- 4.5 GPM @ 45 PSI
- Certified to meet or exceed the following codes and standards:  
ASME A112.18.1/CSAB 125.1-2011

Pressure Balance  
Shower by Shower Set  
1.009367  
(1.009367T Trim Only)

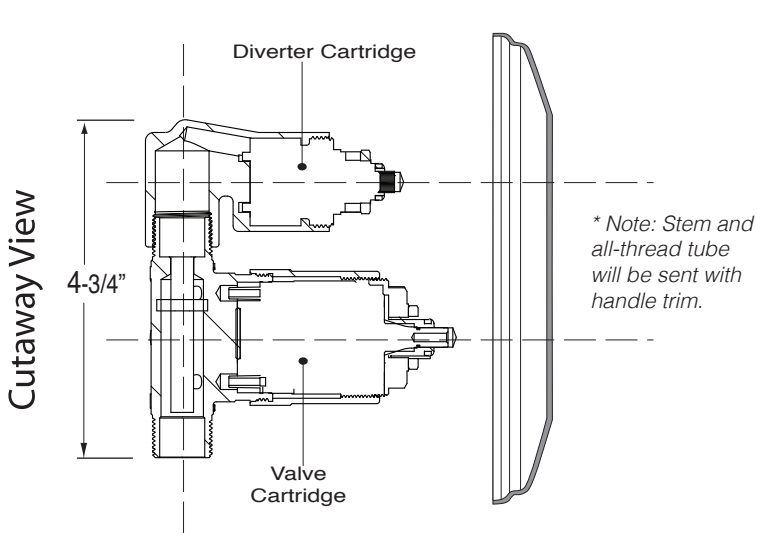

*Note: MUST purchase showerhead, arm, flange, and handshower option separately.*

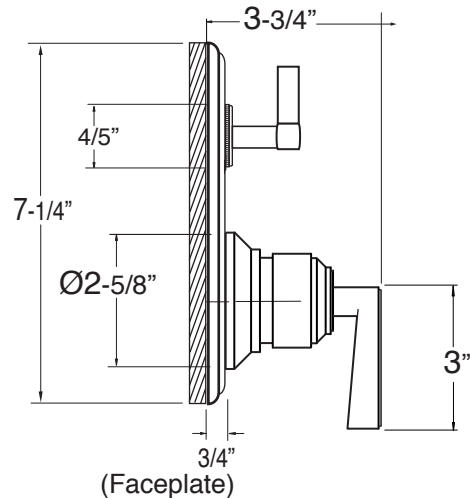
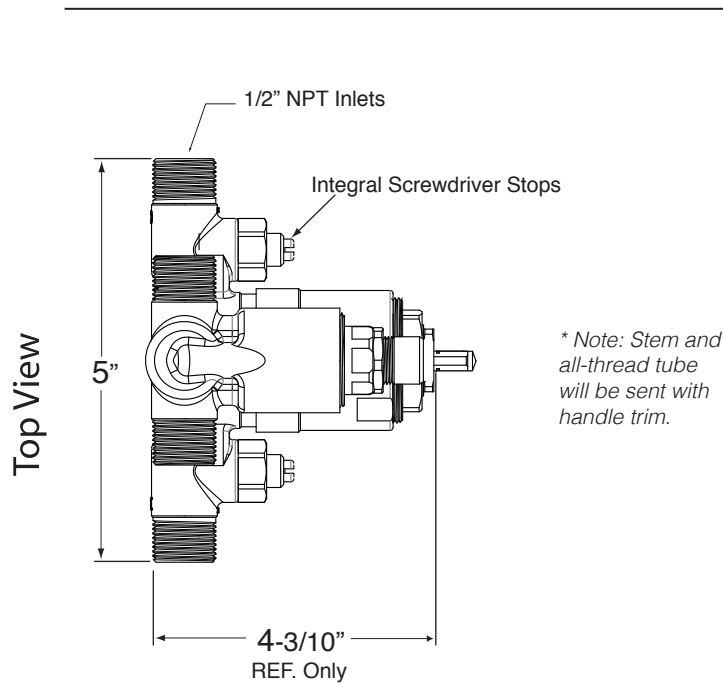

Note: Measurements are subject to change or cancellation. No responsibility is assumed for use of superseded or voided pages.