

Features:

- Forged brass construction
- Ceramic disk valve cartridge 18.30.865
- Adjustable hot limit safety stop
- Reversible cartridge
- 5.6 GPM @ 45 PSI
- Certified to meet or exceed the following codes and standards:
ASME A112.18.1/CSAB 125.1-2012

Pressure Balance Shower Set
1.003064
(1.003064T - Trim Only)

Cutaway View

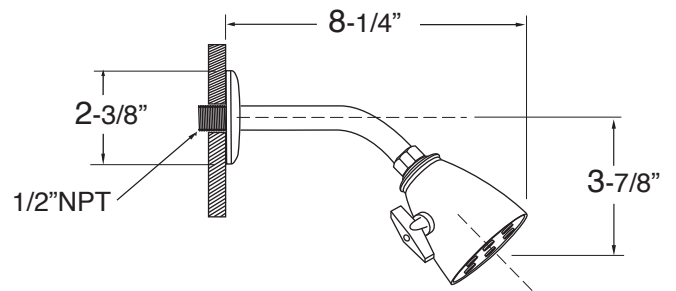
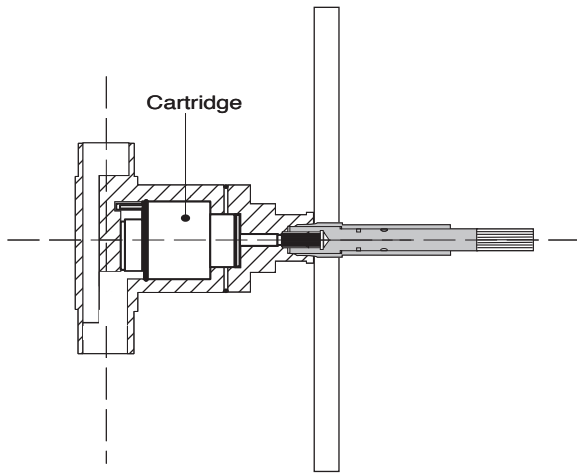

Top View

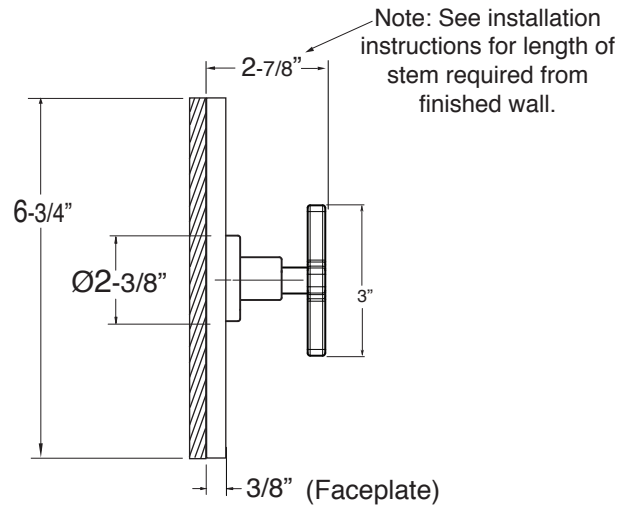
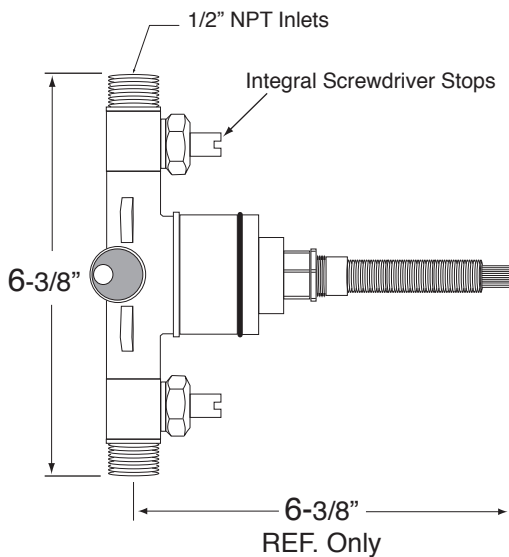

Note: Measurements are subject to change or cancellation. No responsibility is assumed for use of superseded or voided pages.