

### Features

Solid brass construction  
Euro-motion ceramic disc 35 mm valve cartridge  
Independent rotational and pivoting lever handle elements  
Two-function, toggle-control spray engine with solid brass housing  
Magnetic docking system secures spray engine to spout  
Pivoting-ball spray engine inlet fitting for enhanced directional control  
8.18" (20.8 cm) spout height at outlet  
7.47" (19.0 cm) spout reach (c-c)  
ADA Compliant (Handles Only)  
1.8 GPM (6.8 LPM) Max

### PULL-DOWN PREP SINK / BAR FAUCET

# 2940-5223



### Codes / Standards Compliance

Meets or exceeds the following at date of manufacture:

ASME A112.18.1/CSA B125.1  
IAPMO/cUPC  
NSF/ANSI/CAN 61, SECTION 9  
NSF/ANSI 372  
IPC  
ADA & ICC/ANSI A117.1 (Handle Only)  
Energy Policy Act of 1992  
California Energy Commission  
ASME A112.18.3 (Back Flow)  
All applicable US Federal and State material regulations

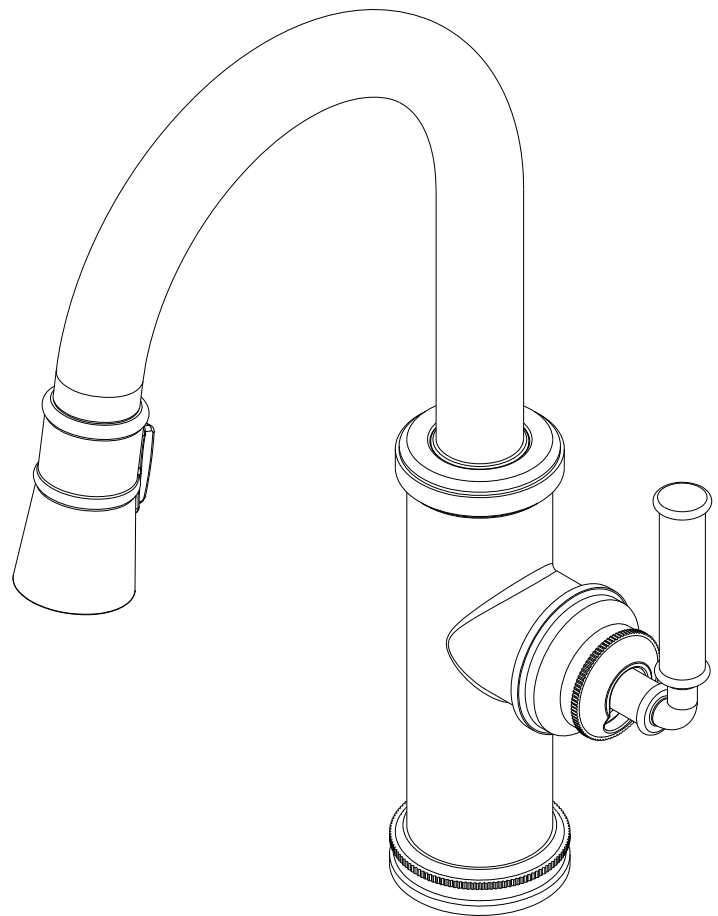

# 2940-5223

## PRODUCT DIMENSIONS *(Units are in inches)*

Product Dimensions are provided for reference only. For specific product installation guidelines, please reference the Installation Instructions of the product being installed.

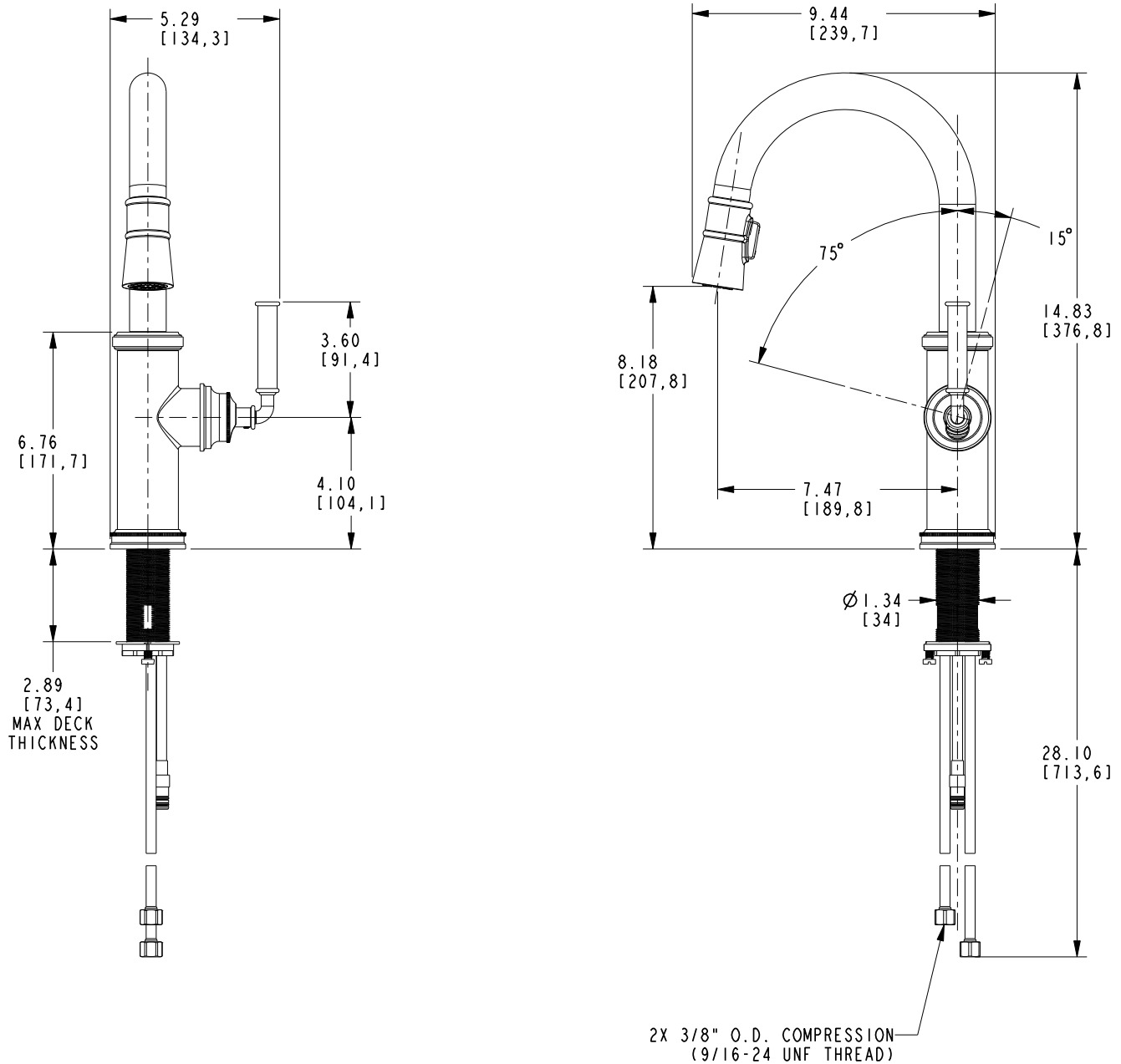

PULL-DOWN PREP SINK / BAR FAUCET

2940-5223

Page 2 of 2  
EN- 5002  
REV M

**NEWPORT BRASS**  
Flawless Beauty. From Faucet to Finish.

t: 949.417.5207 | [www.newportbrass.com](http://www.newportbrass.com)  
©2025 NewportBrass