

FLATIRON MUS-301SB

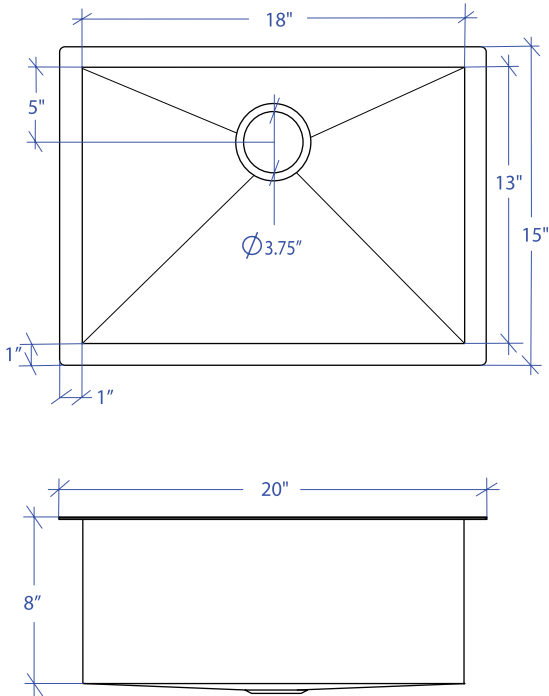

*Custom ADA compliant versions are available



- FEATURES**
 16-gauge type 304 stainless steel
 90° zero radius design
- TECHNICAL INFORMATION**
 External dimension: 20" Lx15" Wx8" D
 Basin dimensions: 18" Lx13" Wx8" D
 Rim width: 1"
 Rim thickness: 1/16"
- FINISHES**
 Satin brushed stainless steel
- INSTALLATION OPTIONS**
 Under-mount
- MINIMUM CABINET SIZE (I.D.)**
 Under-mount 23"
- DUAL-MOUNT INSTALLATION**

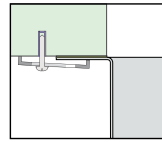

Under-mount

- ACCESSORY OPTIONS**

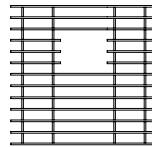

MBG-031SB
Basin Grid

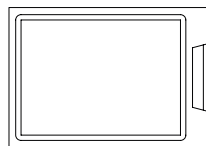

MCB-501BB
Cutting Board

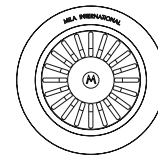

MKD-101SB
Strainer

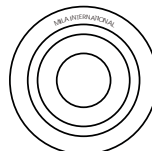

MDC-101SB
Disposal Collar

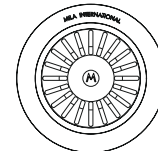

MDC-102SB
Disposal Collar

PROJECT INFORMATION			
Project			
Date	/ /	QTY	
Specifier			
Contact			
Note			

UNDER-MOUNT