

ORION MOUS-805GDSB

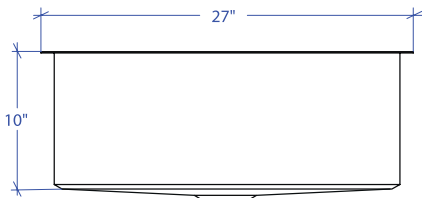

*Custom ADA compliant sinks are available

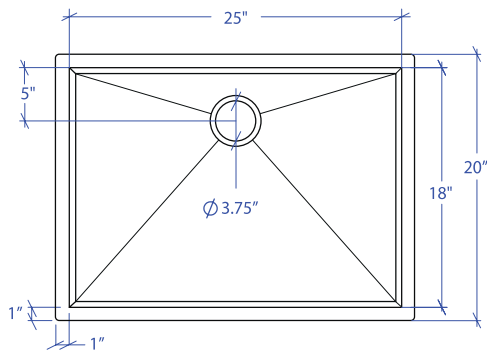

• FEATURES

16-gauge type 304 stainless steel
Bevel basin design

• TECHNICAL INFORMATION

External dimension: 27" Lx20" Wx10" D
Basin dimensions: 25" Lx18" Wx10" D
Rim width: 1"
Rim thickness: 1/16"

• FINISHES

Gold PVD satin brushed stainless steel

• INSTALLATION OPTIONS

Under-mount

• MINIMUM CABINET SIZE (I.D.)

Under-mount 30"

• US DESIGN PATENT D618,324 S

• DUAL-MOUNT INSTALLATION

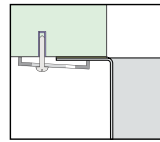

Under-mount

• ACCESSORY OPTIONS

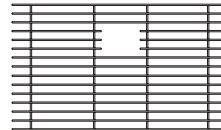

MBG-085GDSB
Basin Grid

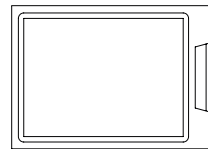

MCB-801BB
Cutting Board

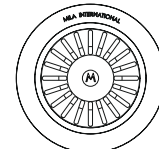

MKD-101GDSB
Strainer

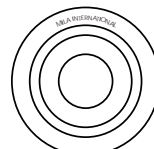

MDC-101GDSB
Disposal Collar

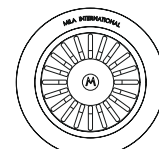

MDC-102GDSB
Disposal Collar

PROJECT INFORMATION

Project			
Date	/ /	QTY	
Specifier			
Contact			
Note			