

# ORION MOUS-803SB

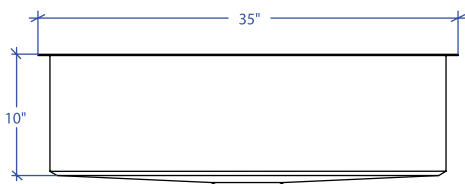

\*Custom ADA compliant sinks are available

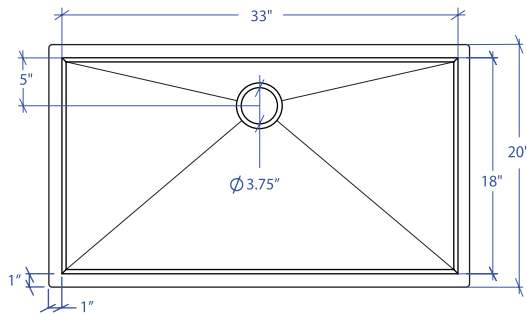

- FEATURES**  
 16-gauge type 304 stainless steel  
 Bevel basin design
- TECHNICAL INFORMATION**  
 External dimension: 35" Lx20" Wx10" D  
 Basin dimensions: 33" Lx18" Wx10" D  
 Rim width: 1"  
 Rim thickness: 1/16"
- FINISHES**  
 Satin brushed stainless steel
- INSTALLATION OPTIONS**  
 Under-mount
- MINIMUM CABINET SIZE (I.D.)**  
 Under-mount 38"
- US DESIGN PATENT D618,324 S**
- DUAL-MOUNT INSTALLATION**

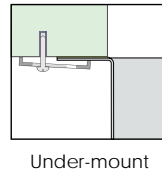

- ACCESSORY OPTIONS**

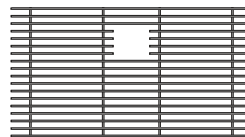

MBG-087SB  
Basin Grid

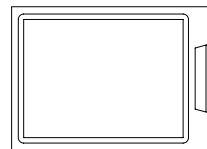

MCB-801BB  
Cutting Board

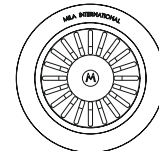

MKD-101SB  
Strainer

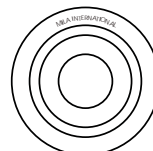

MDC-101SB  
Disposal Collar

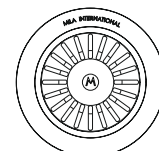

MDC-102SB  
Disposal Collar

PROJECT INFORMATION			
Project			
Date	/ /	QTY	
Specifier			
Contact			
Note			

UNDER-MOUNT