

WORKSTATION MFWS-631GPSB

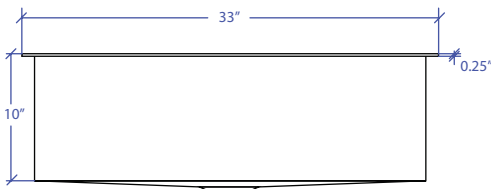

INDUSTRY'S ONLY STAINLESS STEEL SINK DESIGNED SPECIFICALLY TO BE FLUSH-MOUNTED

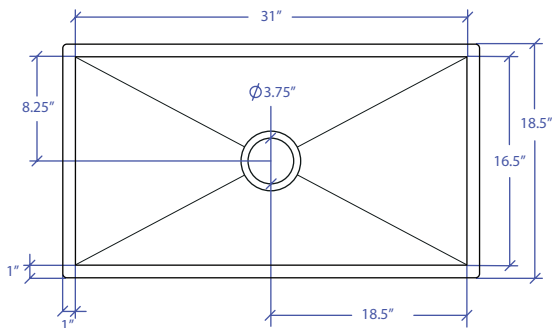

FEATURES

- 16-gauge type 304 stainless steel
- 5-gauge 304 stainless steel rim

TECHNICAL INFORMATION

- External dimension: 33" L x 18.5" W x 10" D
- Basin dimensions: 31" L x 16.5" W x 10" D
- Rim width: 1" • Rim thickness: 1/4"

FINISHES

- Graphite PVD Satin Brushed stainless steel

INSTALLATION OPTIONS

- Flush-mount • Top-mount

MINIMUM CABINET SIZE (I.D.)

- Flush-mount 34"

INSTALLATION TYPE

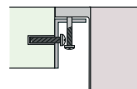

Flush-mount

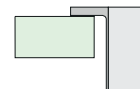

Drop-in



Included MTK-605SS
Flush Mount Kit

OPTIONAL ACCESSORIES

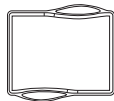

MWCB-651GPSB
Cutting Board

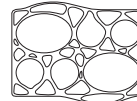

MWBM-651GPSB
Bain Marie

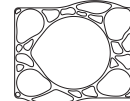

MWSM-651GPSB
Salad Mixer



MWC-651GPSB
Colander



MWSS-651GPSB
Side Sink

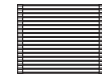

MWRG-651GPSB
Roll up Grid

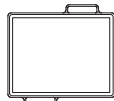

MWCBFLW-651GPSB
Cutting Board

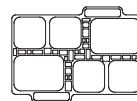

MWBMFLW-651GPSB
Bain Marie

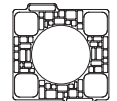

MWSMFLW-651GPSB
Salad Mixer



MWCFW-651GPSB
Colander

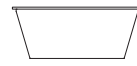

MWSSFLW-651GPSB
Side Sink



MWSA-651GPSB
Salad Spinner Adapter



MBG-631GPSB Basin Grid



MKD-101GPSB
Strainer



MDC-101GPSB
Disposal Collar



MDC-102GPSB
Disposal Collar

US Patent No. 9,988,799 CA Patent No. 2579506
International Patent Pending

PROJECT INFORMATION

Project			
Date	/ /	QTY	
Specifier			
Contact			
Note			

FLUSH-MOUNT