



Levity[®] Plus | K-702429-L

Frameless sliding shower door, 81-5/8" H x 56-5/8 - 59-5/8" W, with 3/8"-thick Crystal Clear glass

Features

- Frameless design emphasizes glass and creates a sleek, minimalist look
- Innovative roller design with stainless steel bearings simplifies installation and provides out-of-plumb adjustability while glass is installed
- 17" (432 mm) vertical handles with 1/4" (6 mm) inside knob for easy opening and closing
- Cushioned center guide provides smooth, quiet sliding action
- CleanCoat[®]+ glass coating creates a hydrophobic barrier that repels water, soap scum, and residue, saving time and protecting shower doors 10 times longer than original CleanCoat. (Based on 2021 internal wear/abrasion testing using a microfiber cloth.)
- Smooth, easy-to-clean wall jambs
- Tempered glass ensures enhanced safety and durability



Available Colors/Finishes

Color tiles intended for reference only.

- SHP Bright Polished Silver
- BL Matte Black
- 2MB Vibrant Brushed Moderne Brass
- BNK Anodized Brushed Nickel



1-800-4KOHLER (1-800-456-4537)

Kohler Co. reserves the right to make revisions without notice to product specifications.

For the most current specification sheet, go to www.kohler.com USA or www.kohler.ca Canada.

4-15-2026 6:21 - US-CA

THE BOLD LOOK
OF **KOHLER**

Codes/Standards

ANSI Z97.1 (Tempered Glass)
CAN/CGSB-12.1
CPSC 16CFR 1201

Technical Information

All product dimensions are nominal.

Base-To-Wall Radius - Maximum: 1/2" (13 mm)
Shower Ledge Minimum Flat: 2-1/2" (64 mm)
Shower Wall Minimum Flat: 3-1/2" (89 mm)
Weight: 176.49 lbs (80.1 kg)

Material

- Frameless, 3/8" (10 mm) thick Crystal Clear tempered glass
 - Anodized aluminum prevents rust and corrosion
-

Warranty

See website for detailed warranty information.

KOHLER® Bath and Shower Doors Ten-Year Limited Warranty



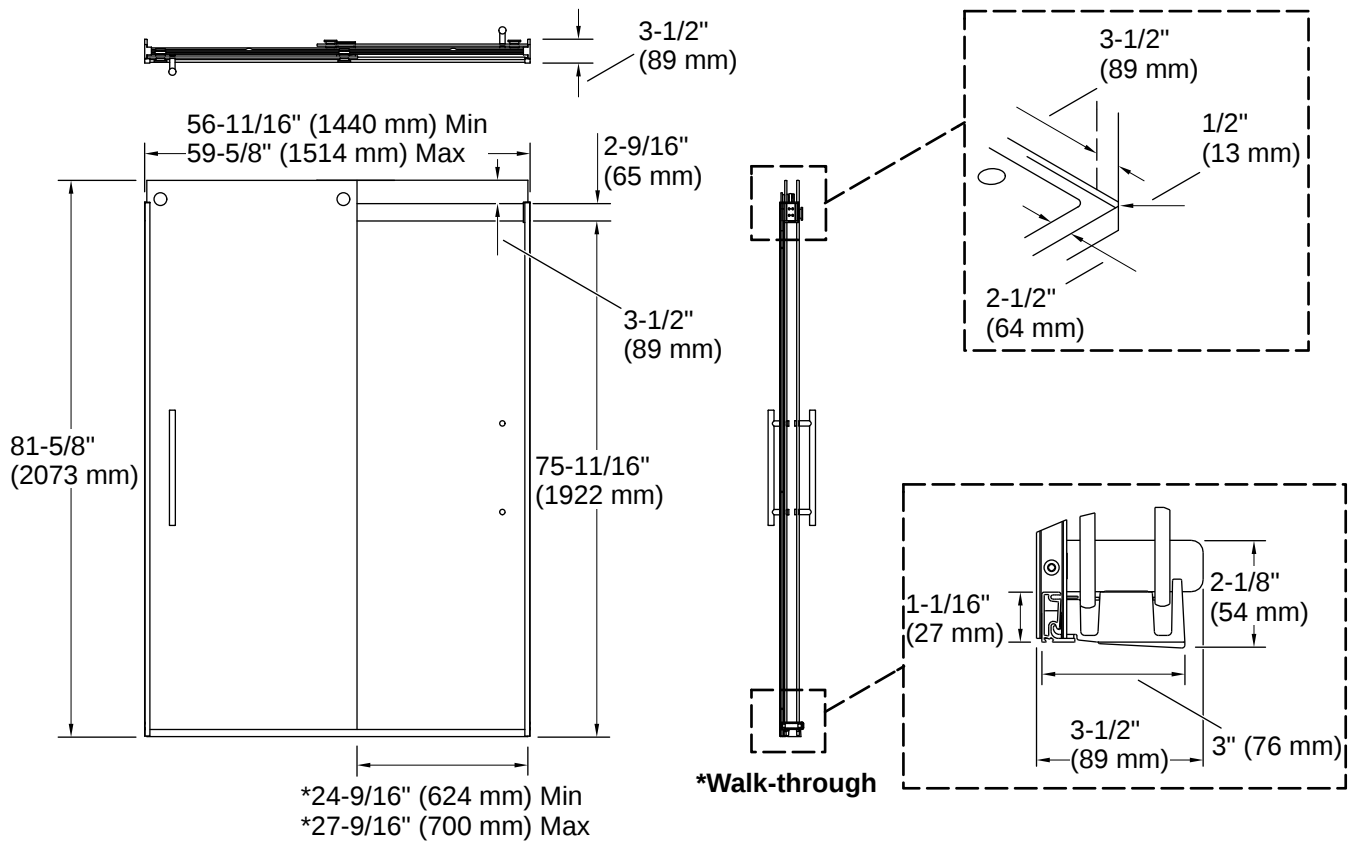

Installation

- Fits opening widths 56-5/8" - 59-5/8" (1438 -1514 mm)
- 81-5/8" (2073 mm) high, with a lofty 75-5/8" (1921 mm) minimum head clearance
- 3" (76 mm) width adjustment
- Out-of-plumb adjustability simplifies installation
- For residential use only
- Not for use in hospitality

Installation Notes

Install this product according to the installation instructions.

The vertical opening should be a minimum of 84-5/8" (2149 mm) to allow for installation clearance.

