



Embark™ | K-56005

Premium XL 35" x 26" rectangular two-door medicine cabinet

Features

- 4" (102 mm) -deep shelves offer more room for larger jars, bottles, and grooming supplies
- Two adjustable tempered-glass shelves offer additional bathroom storage
- Two full-overlay mirrored doors with flat edges
- Mirrored interior
- Three-way adjustable soft-close hinges with 105° opening capability for easy cabinet access
- Easy-hang bracket mounts cabinet securely and simplifies surface-mount applications
- Includes side mirror kit for surface-mount installation



Available Colors/Finishes

Color tiles intended for reference only.

^{NA} NA Not Applicable



1-800-4KOHLER (1-800-456-4537)
Kohler Co. reserves the right to make revisions without notice to product specifications.
For the most current specification sheet, go to www.kohler.com USA or www.kohler.ca Canada.
4-15-2026 6:50 - US-CA

THE BOLD LOOK
OF **KOHLER**

Codes/Standards

None Applicable

Technical Information

All product dimensions are nominal.

Lighting Included: No
Mirror Type: Polished Edge

Cutout
Depth: 5" (127 mm)

Material

- Anodized aluminum construction with a durable rustproof and chip-resistant finish
-

Warranty

See website for detailed warranty information.

KOHLER® One-Year Limited Warranty



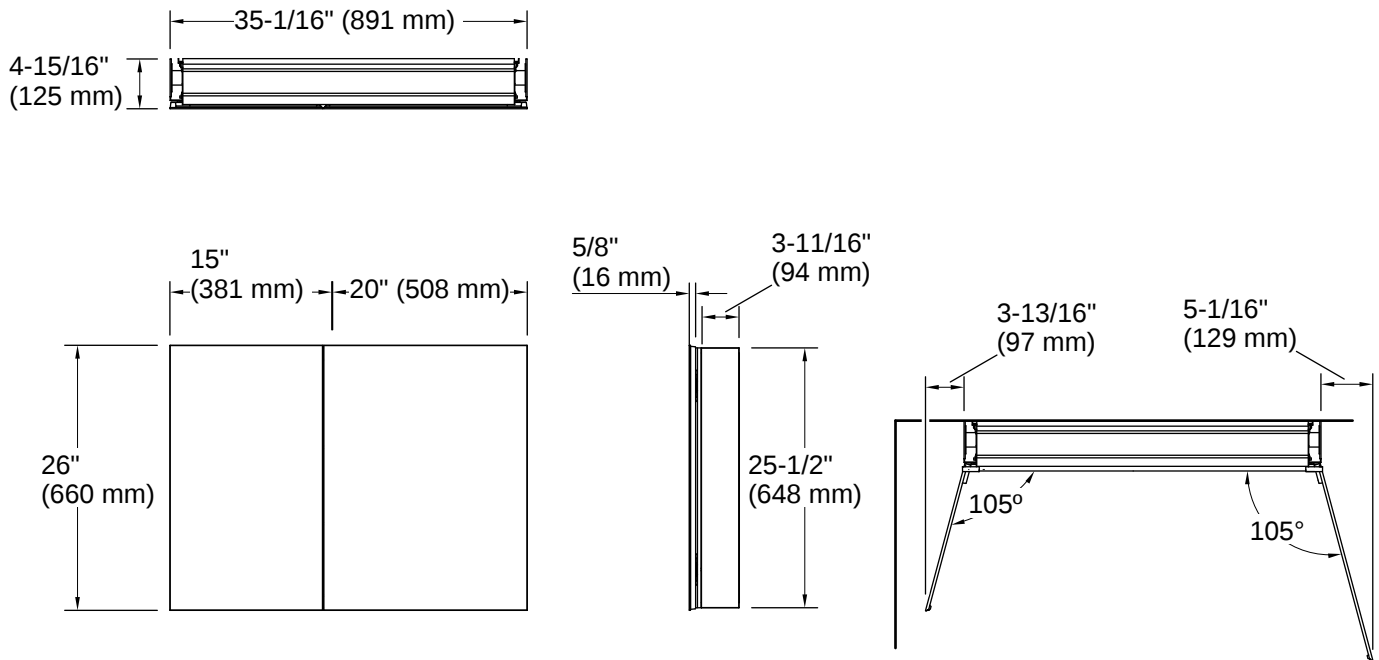

Installation

- Surface-mount or recessed
- Can be installed with left- or right-hand swing
- Includes mounting hardware for surface or recessed installation

Installation Notes

Install this product according to the installation instructions.

