

Prolific® | K-23652

44" undermount single-bowl workstation kitchen sink

Features

- Single bowl
- 10" (254 mm) depth provides generous workspace
- Three graduated ledges in basin allow you to place accessories at your preferred height
- Accessories stack and slide on ledges for a custom arrangement
- Beveled cone-shape bowl slopes into drain, easily disposing debris
- Works with all standard countertop thicknesses. Pairs best with 30 mm countertop thickness if a flush surface between counter and cutting board is desired
- Sink drain with strainer sold separately



Sustainability



Available Colors/Finishes

Color tiles intended for reference only.

NA Stainless Steel



Codes/Standards

ASME A112.19.3/CSA B45.4

Technical Information

All product dimensions are nominal.

Drain Hole Diameter:	3-3/4" (94 mm)
Minimum Base Cabinet Width:	48" (1219 mm)
Basin Configuration:	Single Bowl
Basin Length:	42-1/2" (1080 mm)
Basin Width:	14-15/16" (379 mm)
Basin Depth:	10-1/8" (257 mm)

Material

- Premium 18-gauge stainless steel
-

Recommended Products/Accessories

K-5541 Medium bamboo cutting board

K-23726 Drain treatment

K-23729 Stainless steel cleaner

K-11352 Disposal flange with stopper

K-8801 Sink drain and strainer with tailpiece

K-8799 Sink drain and strainer basket, less tailpiece

Warranty

See website for detailed warranty information.

KOHLER® Stainless Steel Sinks Lifetime Limited Warranty



1-800-4KOHLER (1-800-456-4537)
Kohler Co. reserves the right to make revisions without notice to product specifications.
For the most current specification sheet, go to www.kohler.com USA or www.kohler.ca Canada.
4-15-2026 4:21 - US-CA

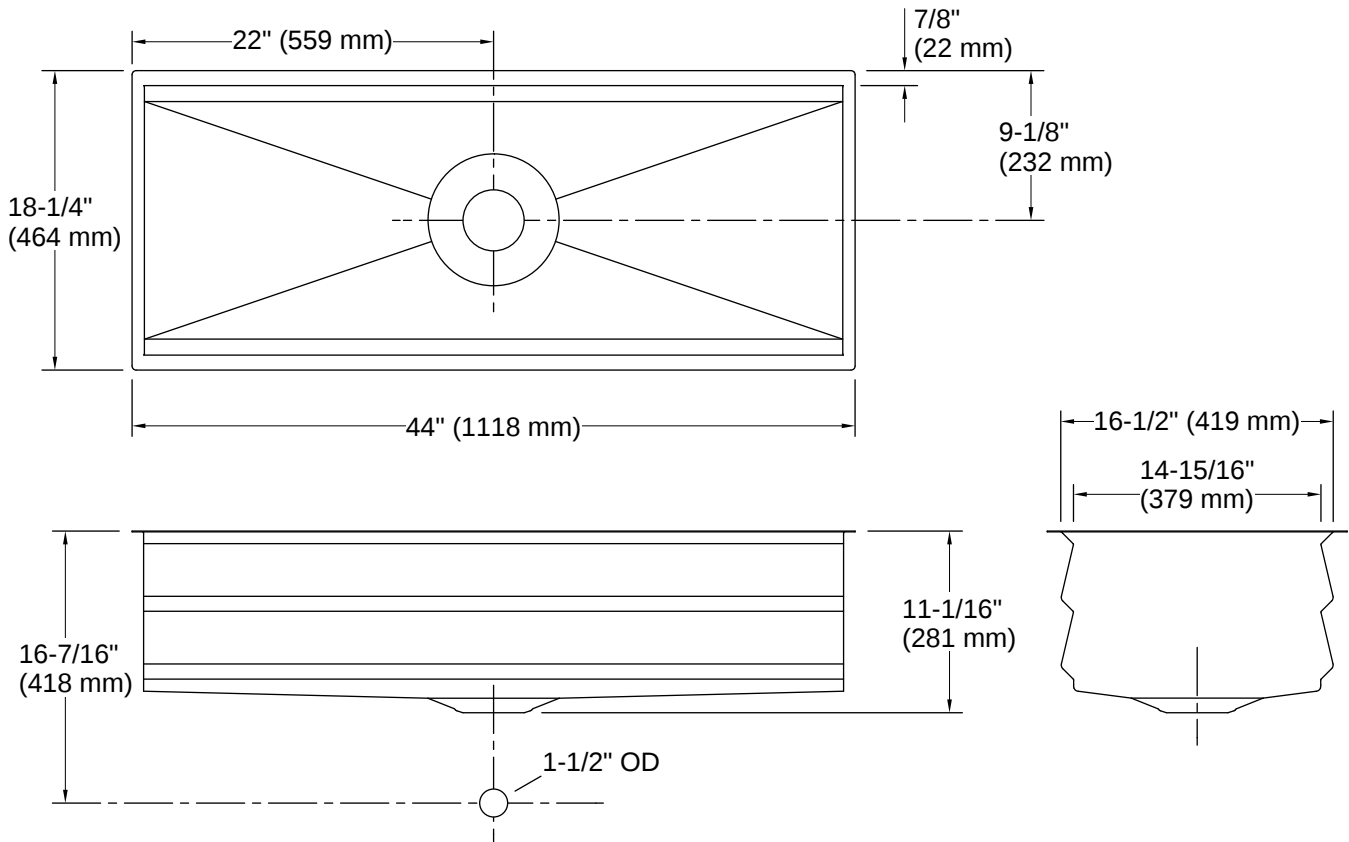

Installation

- Undermount
- Minimum base cabinet width: 45"-48" (45" may require cabinet modifications)

Installation Notes

Install this product according to the installation instructions.

Countertop manufacturer or cutter must use the cut-out template provided with the product, or a current one provided by Kohler Co. (call 1-800-43-FOCUS). Kohler Co. is not responsible for cut-out errors when the incorrect cut-out template is used.

