



Archer® | K-1122-GH

60" x 32" drop-in Heated BubbleMassage™ air bath

Features

- 120 airjets release thousands of heated bubbles that surround and support the body in a warm massage
- Automatic and manual purge cycles remove residual water from air channels after use
- Variable-speed blower lets you adjust massage intensity to 18 levels
- Comfort Depth® design offers a convenient 19" step-over height while retaining the same depth as a standard 21" bath
- Integral lumbar support
- Slotted overflow allows for deep soaking
- Textured bottom surface
- Coordinates with other products in the Archer collection
- Built-in 600W BubbleMassage™ heater warms humidified air before it enters the bath
- Automatic and manual purge cycles remove residual water from air channels after use



Available Colors/Finishes

Color tiles intended for reference only.

- 0 White
- 96 Biscuit
- 95 Ice Grey
- 7 Black Black



1-800-4KOHLER (1-800-456-4537)
Kohler Co. reserves the right to make revisions without notice to product specifications.
For the most current specification sheet, go to www.kohler.com USA or www.kohler.ca Canada.
4-15-2026 4:15 - US-CA

THE BOLD LOOK
OF **KOHLER**

Codes/Standards

ADA compliant when installed to the specific requirements of these regulations.



ASME A112.19.7/CSA B45.10
CSA B45.5/IAPMO Z124
ASTM E162
ASTM E662
UL 1795
CSA C22.2 No. 218.2
ADA
ICC/ANSI A117.1
cUL Listed
UL Listed

Technical Information

All product dimensions are nominal.

Drain Location:	Reversible
Drain Hole Diameter:	2-1/4" (57 mm)
Minimum Flat for Door:	2-1/8" (54 mm)
Basin Area, Bottom:	45-1/8" x 19-11/16" (1146 mm x 500 mm)
Basin Area, Top:	52-3/4" x 25-5/16" (1340 mm x 643 mm)
Water Depth:	15" (381 mm)
Water Capacity:	58 gal (219.6 L)
Minimum Floor Load:	45 lbs/ft ²
Weight:	84 lbs (38.1 kg)
Cutout:	Drop-in, 58-1/2" x 30-1/2" (1486 mm x 775 mm)

Material

- Acrylic

Recommended Products/Accessories

- K-1446 Remote installation kit for BubbleMassage™ air baths
- K-23726 Drain treatment
- K-23732 Tub & shower cleaner

Required Products/Accessories

- K-7271 Slotted overflow brass bath drain
- or
- K-7272 Slotted overflow bath drain

Technology

- Auto-shutoff timer on blower allows users to enjoy Heated BubbleMassage™ experience for 60 minutes before turning off
- User interface: electronic keypad control

Required Electrical Service

Two dedicated circuits required, protected with Class A Ground-Fault Circuit-Interrupter (GFCI). Outside North America, this device may be known as a Residual Current Device (RCD).

Blower:	120 V, 15 A, 60 Hz
Heater:	120 V, 15 A, 60 Hz

Electrical Component Ratings

Blower:	120 V, 10 A
Heater:	120 V, 5 A, 60 Hz, 620 W

Warranty

See website for detailed warranty information.

KOHLER® Plastic Baths and Shower Bases Lifetime Limited Warranty|KOHLER® Hydrotherapy Components Five-Year Limited Warranty



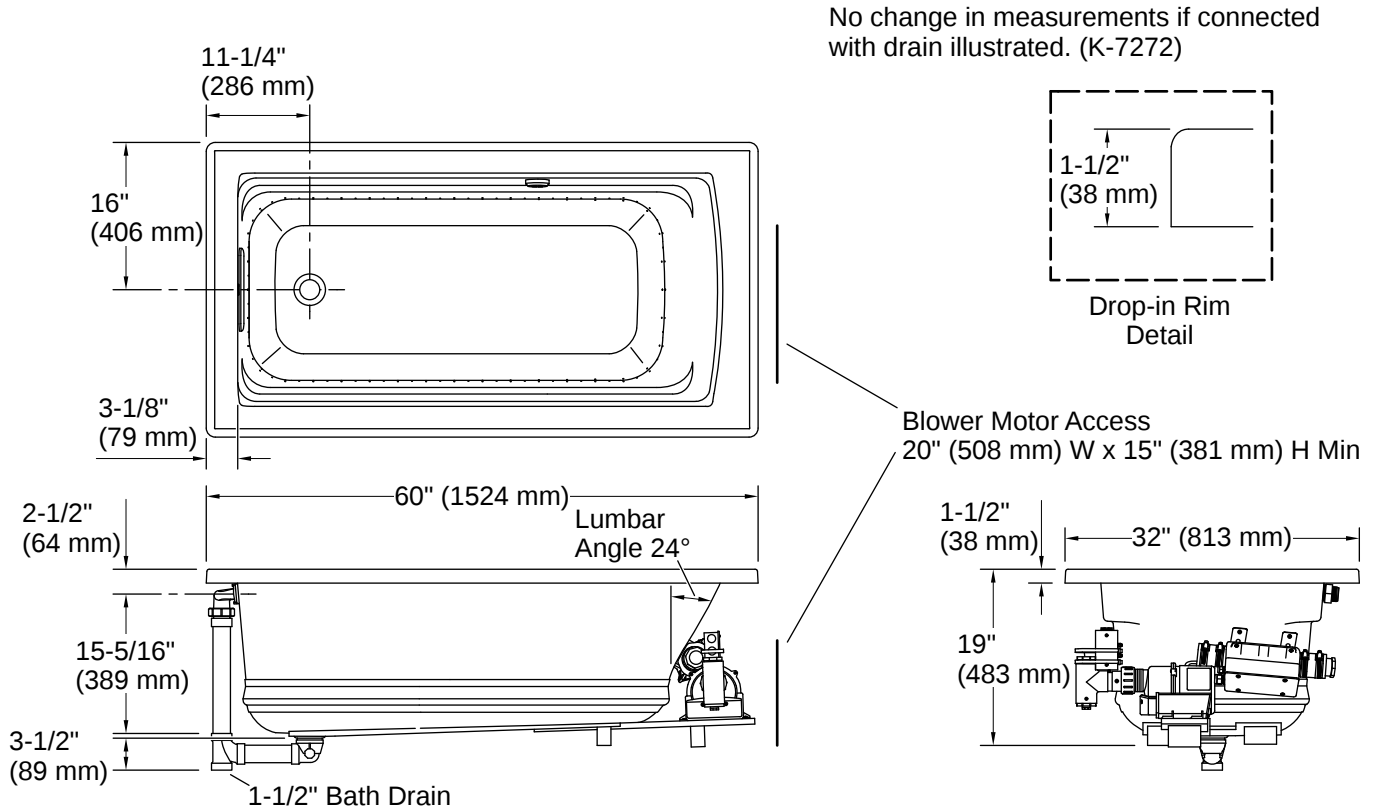

Installation

- Reversible drain
- Drop-in
- Requires Clearflo slotted overflow bath drain (sold separately)

Installation Notes

Install this product according to the installation instructions.

Measure your actual product for rough-in details.

The hot water supply should be 70% of the capacity of the bath or greater. Installations will vary.

This product is designed for drop-in installation only. It is not suited for use in a three-wall alcove with an overhead shower.

Remote blower installation kit is available for relocating the blower. Provide access for servicing the blower.

Do not relocate or alter the PVC tee or coiled flexible tubing connected to the blower. Follow the blower relocation instructions exactly.

ADA compliant when installed to the specific requirements of these regulations.

