

Plan Care

35901014800 Support rail

PRODUCT



DRAWING

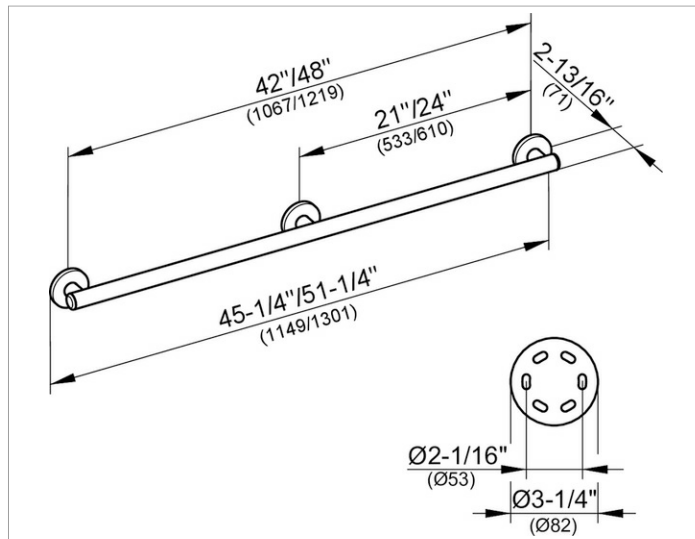

PRODUCT ATTRIBUTES

for horizontal or vertical installation

SURFACE

chrome-plated

SPECIFICATIONS

KEUCO PLAN CARE grab rail 35901014800
 High shine chrome-plate grab rail
 in esthetic, practical and ergonomic Design
 provided with a third wall mounting set (in the middle)
 For horizontal or vertical Fitting up to 253 Lb load capacity,
 anti-static,
 easy to clean
 Pipe diameter 1-5/16" (33 mm),
 Rosette Diameter 3-1/4" (82 mm),
 Base measurement 48" (1219 mm),
 with a Total Width of 51-1/4" (1301 mm),
 Projection 2-13/16" (71 mm),
 Wall to inside edge measurement 1-1/2" (38 mm).
 The Support handle will be at 6 places discretely mounted,
 Can't be combined with a shower seat
 ADA Compliant

This product is no stronger than the fixings and wall structure to which it is attached and it must be firmly secured to function as intended

Warranty: KEUCO products are covered by a 5-year manufacturer's warranty, in effect from the date of purchase. During this time, proven product defects will be remedied free of charge. Warranty claims must be filed in writing, including a detailed description of the defect immediately after a defect has occurred. For a copy of our detailed product warranty policy, please contact us at office-usa@keuco.com.

Installation: KEUCO products must be installed by a qualified professional in accordance with the respective installation guidelines and any applicable federal / local building codes and regulations.