

Edition 400

21513171351 Mirror cabinet

PRODUCT



DRAWING

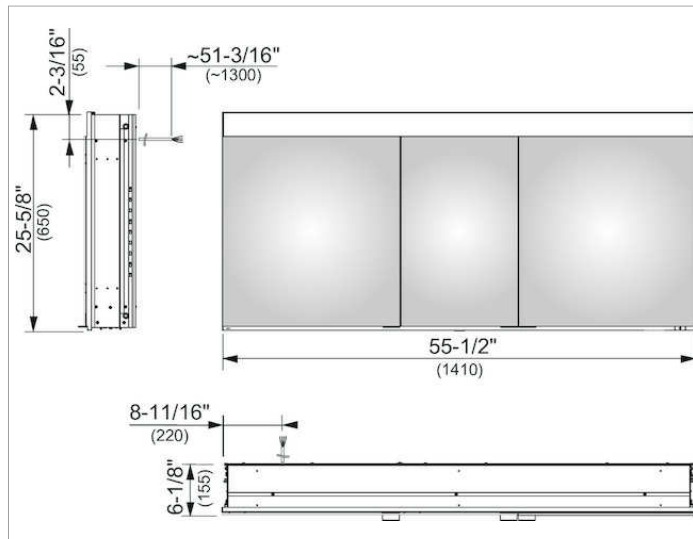

PRODUCT ATTRIBUTES

for recessed installation,
 1 light color, 4000 kelvin (neutral white)
 3 hinged double sided crystal mirrored doors,
 Body: aluminum silver anodized
 interior rear wall mirrored
 Operation:
 key panel with capacitive touch sensor,
 optional to be operated via the light switch
 Illumination:
 LED 52 watt (lifespan > 30.000 hours)
 infinitely dimmable
 EEK: ,

EQUIPMENT

- 2 sockets
- 2 x 3 adjustable glass shelves
- 2 storage boxes with slidable glass lid
- interior lighting
- soft-closing doors

SURFACE

silver anodized

DIMENSION

55,51 x 25,59 x 6,06 "

SPECIFICATIONS

KEUCO Edition 400 Mirror cabinet 21513171351
 High quality Mirror cabinet in elegant design

for recessed installation,
 1 light color, 4000 kelvin (neutral white)
 3 hinged double sided crystal mirrored doors,
 Body: aluminium silver anodized
 interior rear wall mirrored

Operation:
 key panel with capacitive touch sensor,
 optional to be operated via the light switch

Illumination:
 LED 52 watt (lifespan > 30.000 hours)
 infinitely dimmable

- 2 sockets
- 2 x 3 adjustable glass shelves
- 2 storage boxes with slidable glass lid
- interior lighting
- soft-closing doors

55-9/16" x 25-9/16" x 6-1/16"

silver anodized

Warranty: KEUCO products are covered by a 5-year manufacturer's warranty, in effect from the date of purchase. During this time, proven product defects will be remedied free of charge. Warranty claims must be filed in writing, including a detailed description of the defect immediately after a defect has occurred. For a copy of our detailed product warranty policy, please contact us at office-usa@keuco.com.
Installation: KEUCO products must be installed by a qualified professional in accordance with the respective installation guidelines and any applicable federal / local building codes and regulations.