

Royal Match

12802171351 Mirror cabinet

PRODUCT



DRAWING

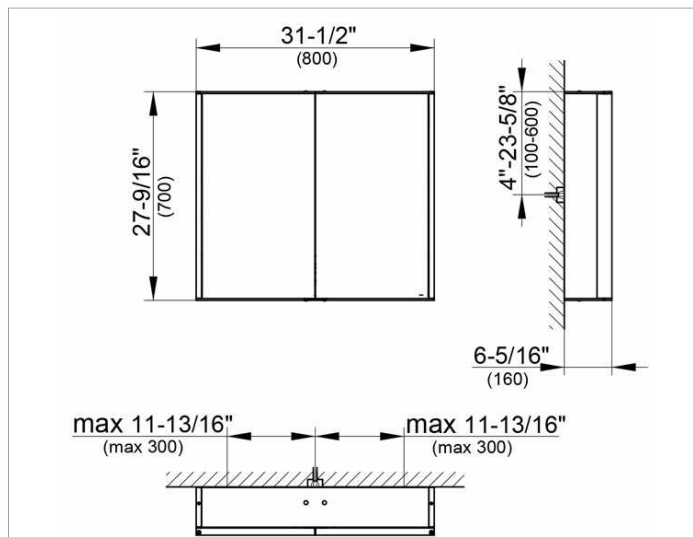

PRODUCT ATTRIBUTES

wall mounted,
2 hinged double sided crystal mirror doors,
body in aluminum silver anodized,
rear panel in back-lacquered white glass

Operation:

control panel with capacitive touch sensor,
optional to be operated via the light switch

Illumination:

LED 2 x 12.5 watt (lifespan > 30.000 hours),
light color 3000 kelvin (warm white),
infinitely dimmable

EEK: ,

EQUIPMENT

- 2 sockets (internal)
- 2 x 3 adjustable glass shelves
- interior lighting

SURFACE

silver anodized

DIMENSION

31,5 x 27,56 x 6,3 "

SPECIFICATIONS

KEUCO Royal Match Mirror cabinet 12802171351
High quality Mirror cabinet in elegant design

wall mounted,
2 hinged double sided crystal mirror doors,
body in aluminium silver anodized,
rear panel in back-lacquered white glass

Operation:

control panel with capacitive touch sensor,
optional to be operated via the light switch

Illumination:

LED 2 x 12,5 watt (lifespan > 30.000 hours),
light color 3000 kelvin (warm white),
infinitely dimmable, lamps non-exchangeable

- 2 sockets (internal)
- 2 x 3 adjustable glass shelves
- interior lighting

31-1/2" x 27-9/16" x 6-5/16"

silver anodized

Warranty: KEUCO products are covered by a 5-year manufacturer's warranty, in effect from the date of purchase. During this time, proven product defects will be remedied free of charge. Warranty claims must be filed in writing, including a detailed description of the defect immediately after a defect has occurred. For a copy of our detailed product warranty policy, please contact us at office-usa@keuco.com.

Installation: KEUCO products must be installed by a qualified professional in accordance with the respective installation guidelines and any applicable federal / local building codes and regulations.