











Dispenser free-standing model

84 435 970



- bottle made of crystal glass, matt
- width 60mm
- height 200 mm
- 250 ml bottle
- 59 mm projection

Goes with ELIO, ENO, META SQUARE, SYNC, TARA, TARA ULTRA and MEM

	Chrome	84 435 970-00
	Brushed Platinum	84 435 970-06
	Platinum	84 435 970-08
	Matte White	84 435 970-10
	Dark Chrome	84 435 970-19
	Brushed Durabrass (23kt Gold)	84 435 970-28
	Matte Black	84 435 970-33
	Brushed Champagne (22kt Gold)	84 435 970-46
	Champagne (22kt Gold)	84 435 970-47
	Brushed Chrome	84 435 970-93
	Brushed Dark Platinum	84 435 970-99

Dispenser free-standing model

84 435 970

mm [inches]

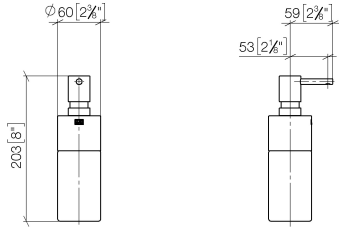

Dispenser free-standing model

84 435 970

Parts for other
finishes can be found
here: [Brushed](#)
[Platinum](#)

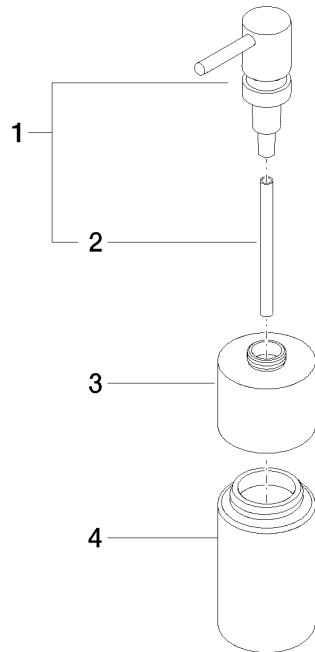

Spare parts list

No.	Item Number	Name	Quantity used	Delivery time
1	05 10 10 535 00-00	dispenser	1	10
2	08 10 10 499 90	Immersion tube for lotion dispenser Ø 8 x 1 x 100 mm	1	2
3	90 10 10 524 00-00	base	1	10
4	08 90 04 001 82	Bottle for lotion dispenser Ø 60 x 109 mm	1	2