







## Tissue holder without cover

---

83 500 705

- width 200mm
- height 35 mm
- 70 mm projection



	Chrome	83 500 705-00
	Brushed Platinum	83 500 705-06
	Dark Chrome	83 500 705-19
	Brushed Champagne (22kt Gold)	83 500 705-46
	Champagne (22kt Gold)	83 500 705-47
	Brushed Dark Platinum	83 500 705-99

## Tissue holder without cover

---

83 500 705

mm [inches]

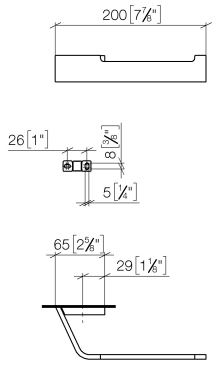

## Tissue holder without cover

83 500 705

Parts for other  
finishes can be found  
here: [Brushed](#)  
[Platinum](#)

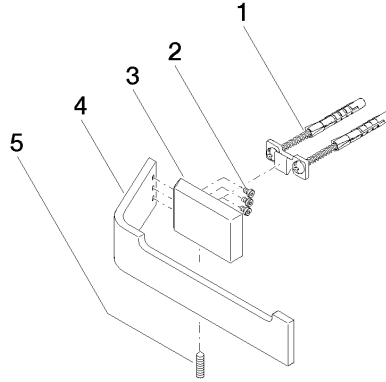

## Spare parts list

No.	Item Number	Name	Quantity used	Delivery time
1	05 17 20 758 00 90	fixing set	1	2
2	09 30 30 191 90	screw	3	2
3	08 17 70 500-00	holder	1	10
4	08 17 70 553-00	holder	1	10
5	04 31 11 113 00 90	pin	1	2