





Wall-mounted basin mixer

36 712 821



- 190 mm projection
- fixed spout
- rectangular, air-enriched flow
- hole diameter valve 37 mm
- hole diameter spout 37 mm
- rosette for deck valve 60 x 60mm
- max. flow 4.5 l/min
- lead-free

	Chrome	36 712 821-00
	Brushed Platinum	36 712 821-06
	Dark Chrome	36 712 821-19
	Brushed Durabronze (23kt Gold)	36 712 821-28
	Brushed Dark Platinum	36 712 821-99

Required miscellaneous



**Concealed wall-mounted mixer
Centred spout** 35 700 970-90
0010

Required miscellaneous

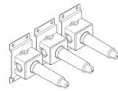

**Concealed wall-mounted mixer
variable positioning** 35 720 970-90
0010

Wall-mounted basin mixer

36 712 821

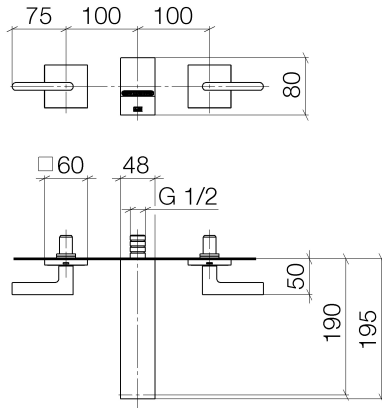

Flow rate chart

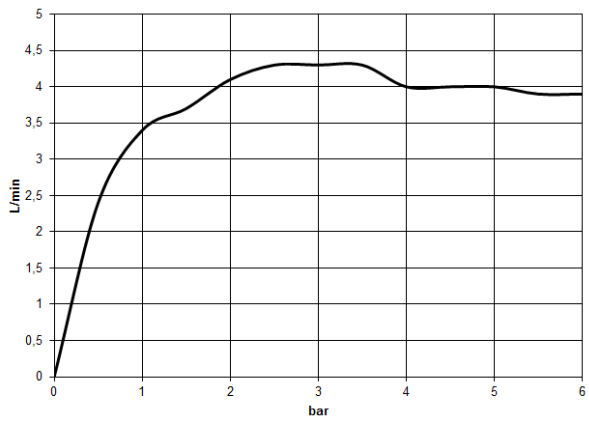

Wall-mounted basin mixer

36 712 821

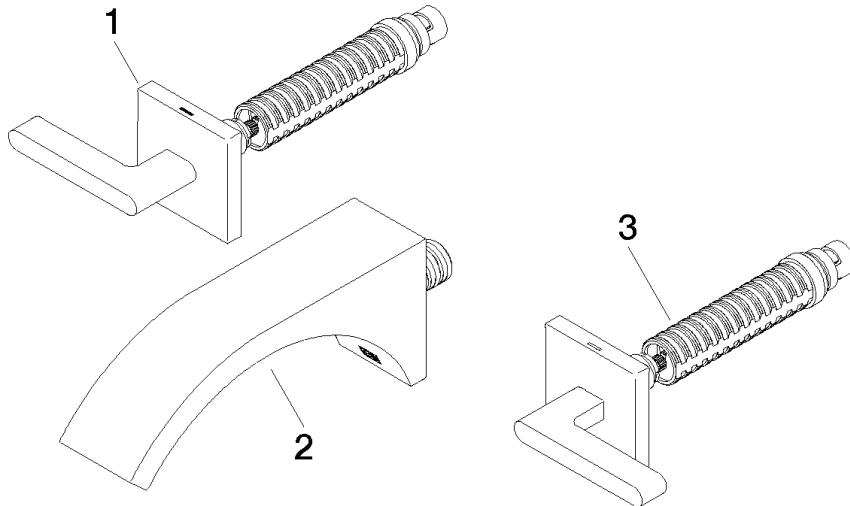

Spare parts list

No.	Item Number	Name	Quantity used	Delivery time
1	36 607 717-00	Wall valve anti-clockwise closing hot 1/2"	1	10
2	13 805 811-00	Wall-mounted basin spout without pop-up waste	1	10
3	36 607 716-00	Wall valve clockwise closing cold 1/2"	1	10