







Wall valve anti-clockwise closing hot 1/2"

36 627 707



- with CASCADE structure
- rosette 60 x 60 mm
- with hot marking
- head part with cut-to-length spindle and sleeve

Codes & standards

	Chrome	36 627 707-00
	Brushed Platinum	36 627 707-06
	Dark Chrome	36 627 707-19
	Brushed Champagne (22kt Gold)	36 627 707-46
	Champagne (22kt Gold)	36 627 707-47
	Brushed Dark Platinum	36 627 707-99

Required miscellaneous



- Wall valve 1/2"** 35 607 970-90
 •min. recess depth 105 mm 0010
 •max. recess depth 150 mm



Wall valve anti-clockwise closing hot 1/2"

36 627 707

mm [inches]

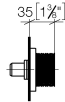

Codes & Standards

ADA

ASME
A112.18.1/CSA
B125.1

Wall valve anti-clockwise closing hot 1/2"

36 627 707

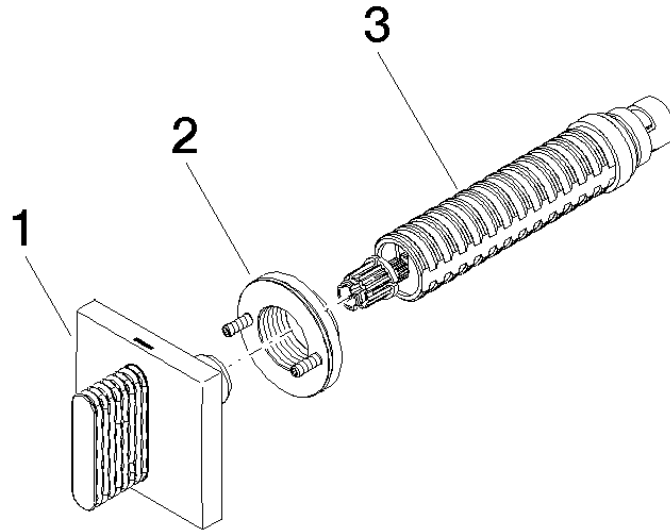

Spare parts list

No.	Item Number	Name	Quantity used	Delivery time
1	90 20 70 053 03-00	handle (hot)	1	10
2	90 21 02 108 00 90	disc	1	2
3	90 90 03 142 00 90	top	1	2