

Single-lever basin mixer without pop-up waste

33 526 782



- 200 mm projection
- fixed spout
- rectangular, air-enriched flow
- height of mixer 340 mm
- height up to aerator 216 mm
- hole diameter 35 mm
- 2 x pressure hose with 3/8" cap nut
- max. flow 4.5 l/min
- lead-free

Codes & standards

- NSF/ANSI 372

	Chrome	33 526 782-00 0010
	Brushed Platinum	33 526 782-06 0010
	Platinum	33 526 782-08 0010
	Dark Chrome	33 526 782-19 0010
	Brushed Durabronze (23kt Gold)	33 526 782-28 0010
	Brushed Champagne (22kt Gold)	33 526 782-46 0010
	Champagne (22kt Gold)	33 526 782-47 0010
	Brushed Dark Platinum	33 526 782-99 0010



Single-lever basin mixer without pop-up waste

33 526 782

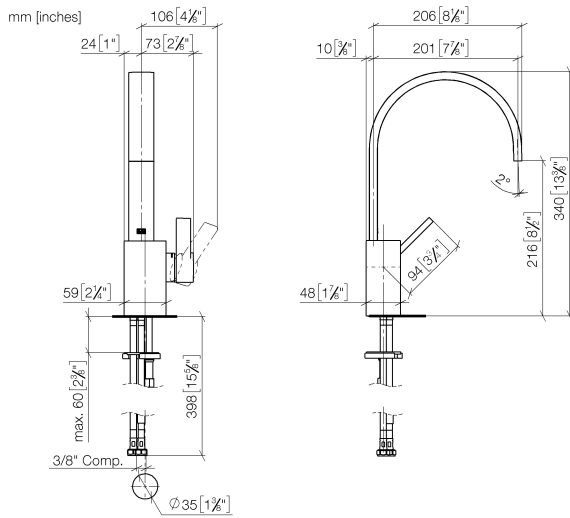

Flow rate chart

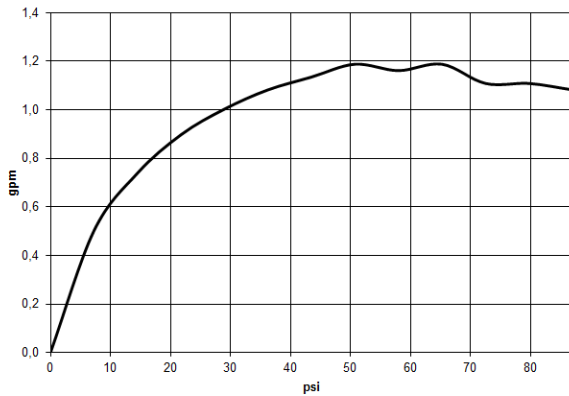

Codes & Standards

ADA

ASME
A112.18.1/CSA
B125.1

California Energy
Commission
(CEC)

NSF/ANSI 372

NSF/ANSI/CAN
61

Single-lever basin mixer without pop-up waste

33 526 782

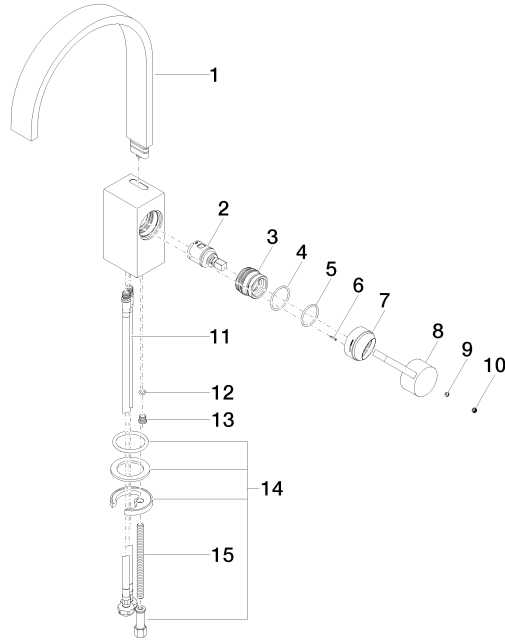

Spare parts list

No.	Item Number	Name	Quantity used	Delivery time
1	90 28 22 152 02-00	spout	1	10
2	90 15 05 042 00 90	cartridge	1	2
3	09 24 04 288 90	nut	1	2
4	09 14 10 137 90	seal	1	2
5	09 14 10 063 90	seal	1	2
6	09 31 11 152 90	pin	1	2
7	09 28 30 028-00	cover	1	10
8	09 20 78 057-00	handle	1	10
9	09 31 11 063 90	pin	1	2
10	09 31 20 109 90	plug	1	2
11	04 30 04 106 00 90	hose	2	2
12	09 14 10 132 90	seal	1	2
13	09 31 20 027 10-00	plug	1	10
14	04 30 11 038 75 90	fixing set	1	2
15	09 31 11 012 90	pin	1	2