

Single-lever basin mixer with pop-up waste





33 500 845



- 130 mm projection
- US pop-up waste (only used in the USA)
- fixed spout
- circular, air-enriched flow
- height of mixer 127 mm
- height up to aerator 75 mm
- hole diameter 35 mm
- 2 x pressure hose with 3/8" cap nut
- max. flow 4.5 l/min
- lead-free

Codes & standards

- NSF/ANSI 372

	Chrome	33 500 845-00 0010
	Brushed Platinum	33 500 845-06 0010
	Dark Chrome	33 500 845-19 0010
	Matte Black	33 500 845-33 0010
	Brushed Chrome	33 500 845-93 0010

Only suitable for basins with an overflow.



Single-lever basin mixer with pop-up waste

33 500 845

mm [inches]

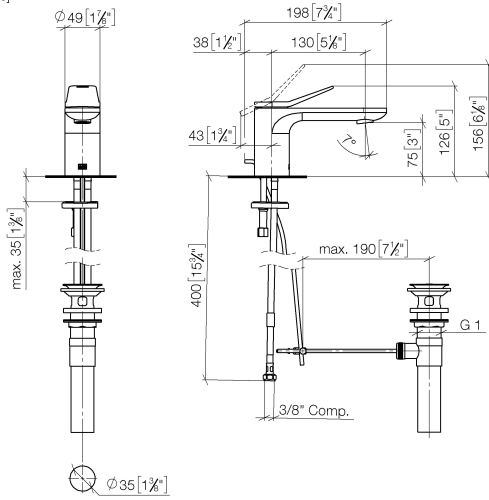

Flow rate chart



Codes & Standards

ADA

ASME
A112.18.1/CSA
B125.1

California Energy
Commission
(CEC)

NSF/ANSI 372

NSF/ANSI/CAN
61

Single-lever basin mixer with pop-up waste

33 500 845

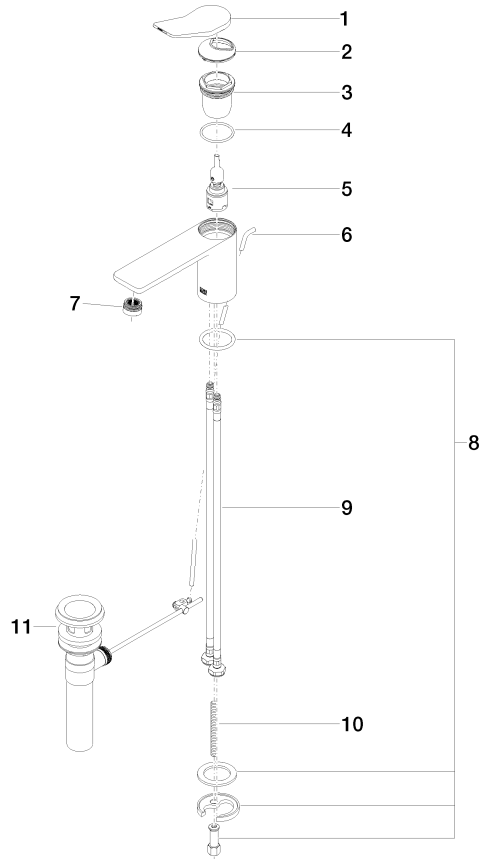

Spare parts list

No.	Item Number	Name	Quantity used	Delivery time
1	90 20 84 020 00-00	handle	1	10
2	09 28 30 034 90	cover	1	2
3	09 23 10 123 90	nut	1	2
4	09 14 10 038 90	seal	1	2
5	90 15 05 042 01 90	cartridge	1	2
6	09 31 09 120-00	pull-rod	1	10
7	90 23 01 161 03-00	aerator	1	10
8	04 30 11 038 75 90	fixing set	1	2
9	04 30 04 102 00 90	High pressure hose 3/8"	2	2
10	09 31 11 011 90	pin	1	2
11	04 11 01 023 00-00	Basin Waste US 1 1/4"	1	2