

Single-lever basin mixer with pop-up waste





33 500 811



- 143 mm projection
- 1 1/4" pop-up waste
- fixed spout
- rectangular, air-enriched flow
- height of mixer 180 mm
- height up to aerator 128 mm
- hole diameter 35 mm
- max. flow 4.5 l/min
- 2 x pressure hose with 3/8" cap nut
- lead-free

Only suitable for basins with an overflow.

Distance from centre of tap hole to wall min. 55 mm
or to front edge of basin min. 40 mm.

	Chrome	33 500 811-00 0010
	Brushed Platinum	33 500 811-06 0010
	Dark Chrome	33 500 811-19 0010
	Brushed Durabronze (23kt Gold)	33 500 811-28 0010
	Brushed Dark Platinum	33 500 811-99 0010

Single-lever basin mixer with pop-up waste

33 500 811

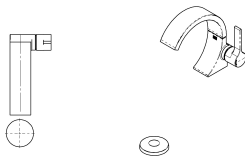
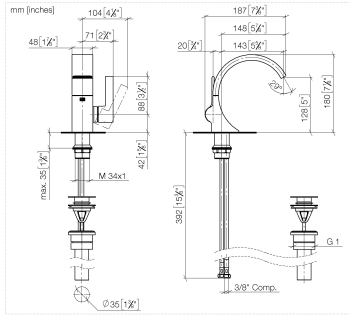

Flow rate chart

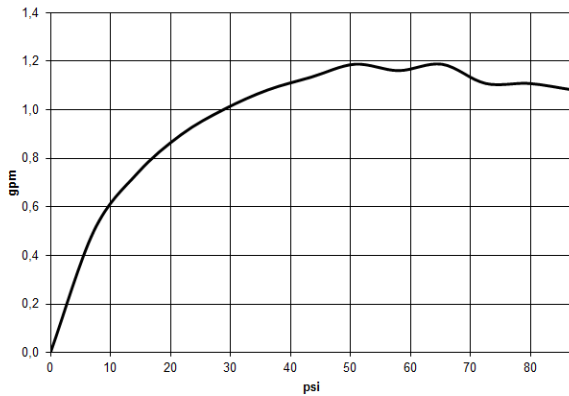

Spare parts list

No.	Item Number	Name	Quantity used	Delivery time
1	90 11 70 012 01-00	spout	1	10
2	09 23 01 172 90	flow reducer	1	2
3	90 15 05 044 00 90	cartridge	1	2
4	09 24 04 266 90	nut	1	2
5	09 28 30 021-00	cover	1	10
6	09 20 80 024-00	handle	1	60
7	09 31 11 030 90	pin	1	2
8	90 31 20 087 00-00	plug	1	10
9	09 31 11 008 90	pin	1	2
10	90 31 20 129 00 90	plug	1	2
11	04 23 10 044 07 90	fixing set	1	2
12	04 30 04 102 00 90	High pressure hose 3/8"	2	2
13	10 125 970-00 0010	Basin Waste 1 1/4"	1	2