

Two-hole mixer with individual rosettes





32 800 625



- 200 mm projection
- pivotable spout 360°
- air-enriched flow
- height of mixer 275 mm
- height up to aerator 180 mm
- hole diameter spout 35 mm
- single-lever mixer hole diameter 35 mm
- 2 x pressure hose with 3/8" cap nut
- max. flow 5.7 l/min at 3 bar flow pressure
- lead-free

Codes & standards

- NSF/ANSI 372

	Chrome	32 800 625-00 0010
	Brushed Platinum	32 800 625-06 0010
	Platinum	32 800 625-08 0010
	Brushed Durabronze (23kt Gold)	32 800 625-28 0010
	Brushed Dark Platinum	32 800 625-99 0010

Operating unit can be positioned freely.

Recommended miscellaneous

AIR SWITCH Control button 10 713 970-00



Recommended miscellaneous

Dispenser with rosette 82 434 970-00



Recommended miscellaneous

Dispenser with rosette 82 444 970-00





Two-hole mixer with individual rosettes

32 800 625

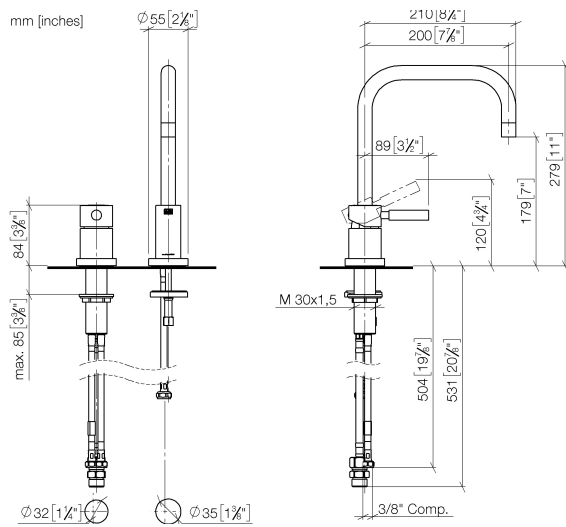

Flow rate chart

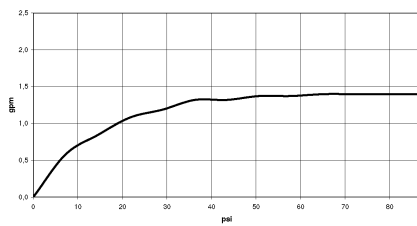

Codes & Standards

ADA

ASME
A112.18.1/CSA
B125.1

California Energy
Commission
(CEC)

NSF/ANSI 372

NSF/ANSI/CAN
61

Two-hole mixer with individual rosettes

32 800 625

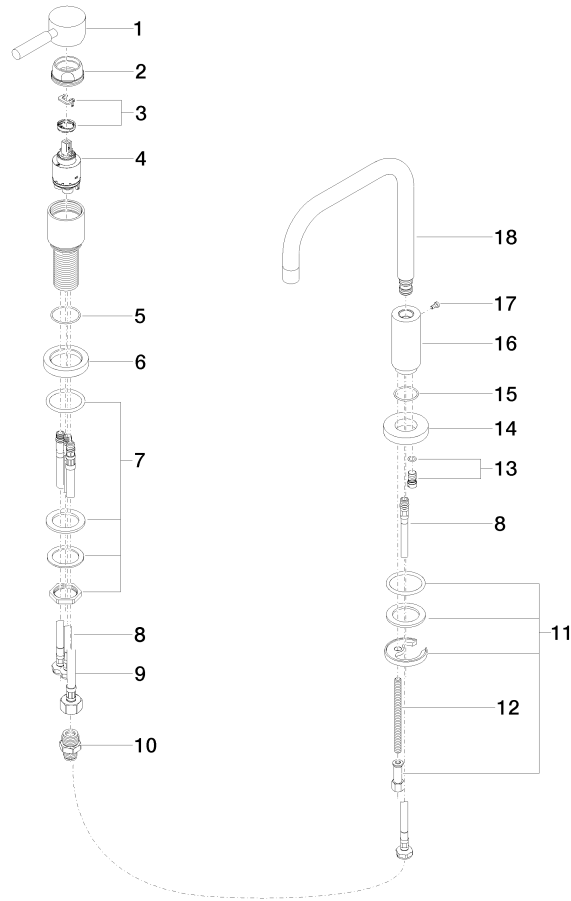

Spare parts list

No.	Item Number	Name	Quantity used	Delivery time
1	90 20 62 040 00-00	handle	1	10
2	09 24 04 107-00	nut	1	10
3	04 28 10 148 00 90	accessories	1	2
4	90 15 05 065 00 90	cartridge	1	2
5	09 14 10 102 90	seal	1	2
6	09 28 10 111-00	rosette	1	10
7	04 23 10 032 46 90	fixing set	1	2
8	04 30 04 106 00 90	hose	3	2
9	04 30 04 019 00 90	hose	1	2
10	90 24 03 514 00 90	nipple set	1	2
11	04 30 11 038 00 90	fixing set	1	2
12	09 31 11 012 90	pin	1	2
13	04 31 20 046 10 92	set	1	2
14	09 28 10 064-00	rosette	1	10
15	09 14 10 120 90	seal	1	2
16	09 11 10 062 10-00	connection	1	10
17	09 30 30 057 90	screw	1	2
18	90 28 22 208 02-00	spout	1	10