

**Single-lever bath mixer for bath rim or tile edge installation**







29 300 660



- hole diameter 35 mm
- max. flow 35.7 l/min at 3 bar flow pressure

**Codes & standards**

Note: Local building codes may require the use of an anti-scald device. Please refer to remote pressure balance valve (35 910 970 90)

	Chrome	29 300 660-00
	Brushed Platinum	29 300 660-06
	Dark Chrome	29 300 660-19
	Matte Black	29 300 660-33
	Brushed Champagne (22kt Gold)	29 300 660-46
	Champagne (22kt Gold)	29 300 660-47
	Brushed Chrome	29 300 660-93

**Single-lever bath mixer for bath rim or tile edge installation**

29 300 660

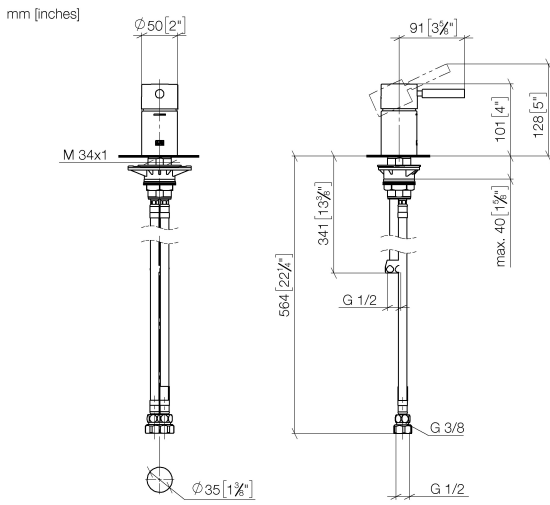

**Flow rate chart**

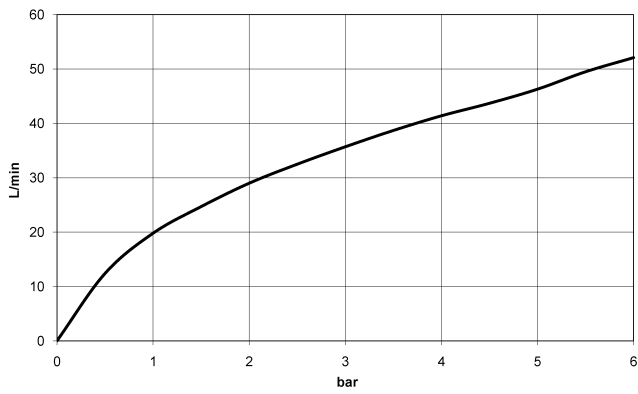

**Codes & Standards**

ASME  
A112.18.1/CSA  
B125.1

## Single-lever bath mixer for bath rim or tile edge installation

29 300 660

Parts for other finishes can be found here: [Brushed](#)  
[Platinum](#)

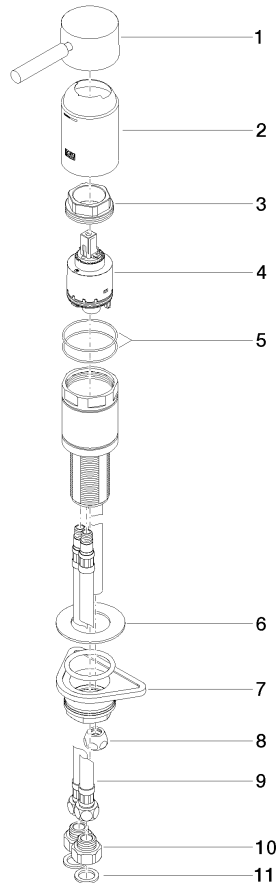

### Spare parts list

No.	Item Number	Name	Quantity used	Delivery time
1	90 20 66 005 00-00	handle	1	10
2	09 28 30 037-00	cover	1	10
3	09 24 04 448 90	nut	1	2
4	90 15 05 039 00 90	cartridge	1	2
5	09 14 10 201 90	seal	1	2
6	09 30 11 060 90	disc	1	2
7	04 23 10 044 02 90	fixing set	1	2
8	04 23 30 041 00 90	threaded connector	1	2
9	04 30 04 021 00 90	hose	1	2
10	09 24 03 185-00	nipple	2	10
11	09 14 05 004 90	seal	2	2