







Two-hole basin mixer without pop-up waste

29 218 811



- 167 mm projection
- fixed spout
- rectangular, air-enriched flow
- height of mixer 198 mm
- height up to aerator 133 mm
- hole diameter spout 35 mm
- hole diameter valve 32 mm
- handle Ø 60mm
- 2 x pressure hose with 3/8" cap nut
- 1x screw-in M 10 x 1 pressure hose, leak-tested
- max. flow 4.5 l/min
- progressive cartridge
- lead-free
- This product can help a building to meet requirements of Green Building Rating Systems, e.g. LEED®, BREEAM®, DGNB, WELL

NOTE: The handle inserts must be ordered separately from the fittings!

	Chrome	29 218 811-00 0010
	Brushed Platinum	29 218 811-06 0010
	Dark Chrome	29 218 811-19 0010
	Brushed Durabronze (23kt Gold)	29 218 811-28 0010
	Platinum / Brushed Platinum	29 218 811-36 0010
	Durabronze / Brushed Durabronze (23kt Gold)	29 218 811-38 0010
	Brushed Dark Platinum	29 218 811-99 0010

Two-hole basin mixer without pop-up waste

29 218 811

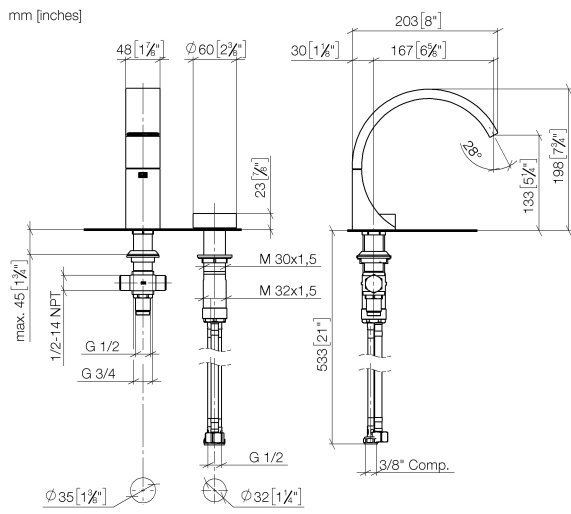

Flow rate chart

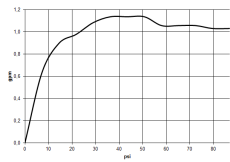

Two-hole basin mixer without pop-up waste

29 218 811

Parts for other finishes can be found here: [Brushed](#)
[Platinum](#)

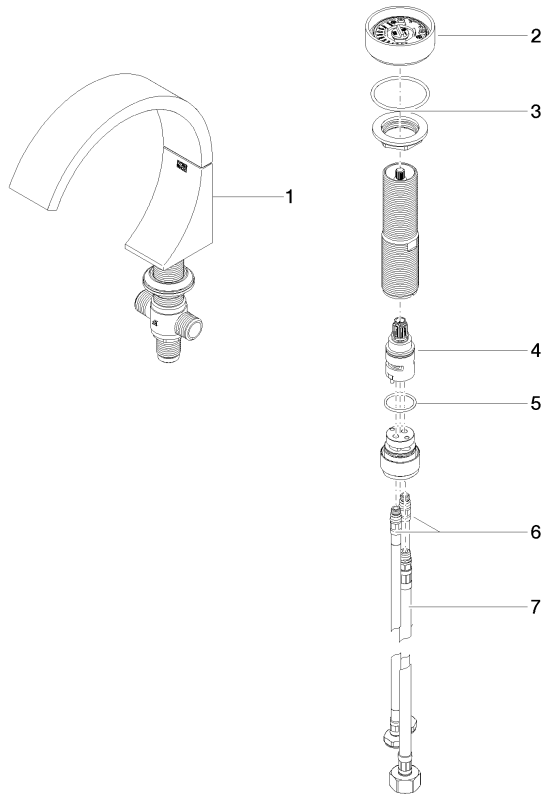

Spare parts list

No.	Item Number	Name	Quantity used	Delivery time
1	13 717 811-00	Deck-mounted basin spout without pop-up waste	1	10
2	90 18 40 290 00-00	handle	1	10
3	04 30 11 038 67 90	fixing set	1	2
4	90 90 03 169 00 90	top	1	2
5	09 14 10 112 90	seal	1	2
6	04 30 04 102 00 90	High pressure hose 3/8"	2	2
7	04 30 04 019 00 90	hose	1	2