

Hand shower set for bath rim or tile edge installation







27 702 660



- normal flow
- with anti-scale system
- rosette Ø 60 mm
- hole diameter 32 mm
- metal shower hose 1750mm with integrated anti-twist protection
- max. flow 6.8 l/min

Codes & standards

Two-piece design allows hose to later be changed without dismantling the fitting.
Intrinsic protection against back flow.

	Chrome	27 702 660-00
	Brushed Platinum	27 702 660-06
	Dark Chrome	27 702 660-19
	Matte Black	27 702 660-33
	Brushed Champagne (22kt Gold)	27 702 660-46
	Champagne (22kt Gold)	27 702 660-47
	Brushed Chrome	27 702 660-93

Hand shower set for bath rim or tile edge installation

27 702 660

mm [inches]

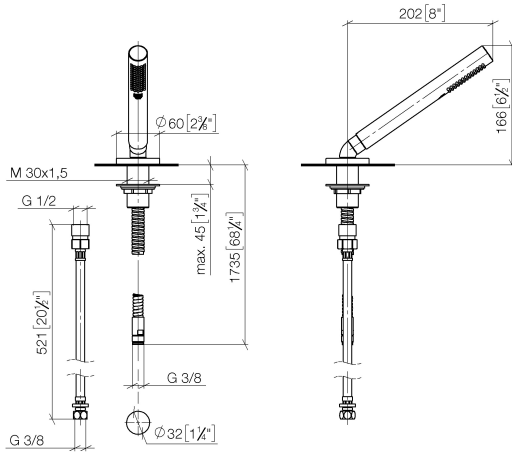

Flow rate chart

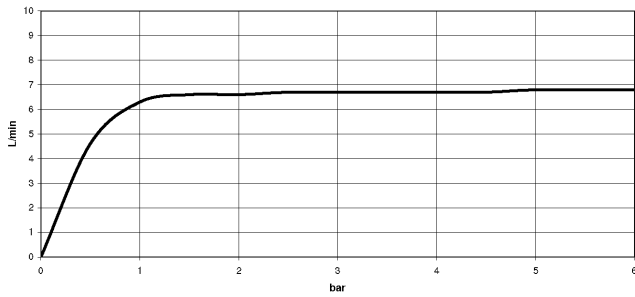

Codes & Standards

ASME
A112.18.1/CSA
B125.1

California Energy
Commission
(CEC)

Hand shower set for bath rim or tile edge installation

27 702 660

Parts for other finishes can be found here: [Brushed](#)
[Platinum](#)

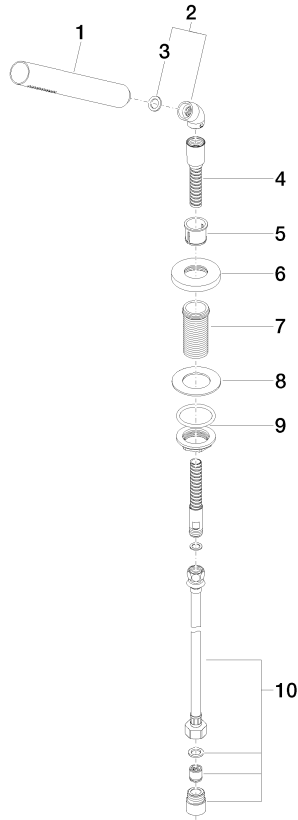

Spare parts list

No.	Item Number	Name	Quantity used	Delivery time
1	90 12 11 140 30-00	shower	1	10
2	28 411 970-00	angle	1	10
3	09 14 20 002 90	seal	1	60
4	28 322 970-00	Metal shower hose 1/2" x 3/8" x 1750 mm	1	2
5	09 18 40 085 90	sleeve	1	2
6	09 27 66 003-00	rosette	1	10
7	09 30 01 090-07	sleeve	1	30
8	09 30 11 060 90	disc	1	2
9	04 23 10 032 46 90	fixing set	1	2
10	12 505 970 90	High pressure hose 1/2" x 3/8" x 500 mm	1	2