

Bath shower set for bath rim or tile edge installation

27 632 661









- 221 mm projection
- complete hand shower set: normal flow
- spout: circular, air-enriched flow
- complete hand shower set with anti-scale system
- automatic bath/shower diverter
- height of mixer 319 mm
- height up to aerator 216 mm
- hole diameter spout 32 mm
- hole diameter single-lever mixer 35 mm
- hole diameter for complete hand shower set 32 mm
- rosette for spout Ø 60mm
- rosette for single-lever mixer Ø 55mm
- rosette for complete hand shower set Ø 60mm
- metal shower hose 1750mm with integrated anti-twist protection
- max. flow 23.5 l/min at 3 bar flow pressure
- max. flow for complete hand shower set 6.8 l/min

Codes & standards

Intrinsic protection against back flow.

Note: Local building codes may require the use of an anti-scald device. Please refer to remote pressure balance valve (35 910 970 90)

	Chrome	27 632 661-00
	Brushed Platinum	27 632 661-06
	Dark Chrome	27 632 661-19
	Matte Black	27 632 661-33
	Brushed Champagne (22kt Gold)	27 632 661-46
	Champagne (22kt Gold)	27 632 661-47
	Brushed Chrome	27 632 661-93

Bath shower set for bath rim or tile edge installation

27 632 661

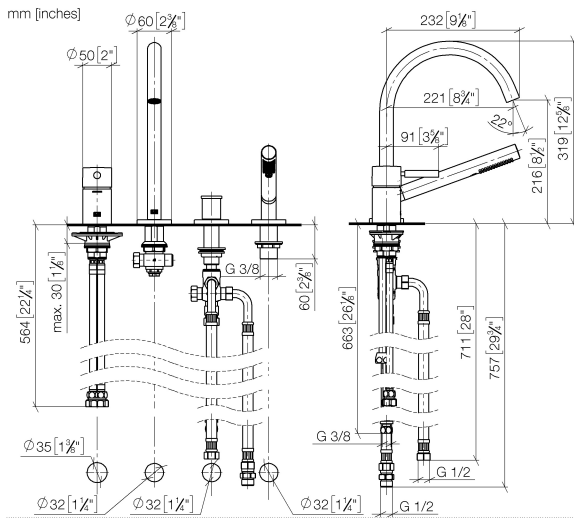

Flow rate chart

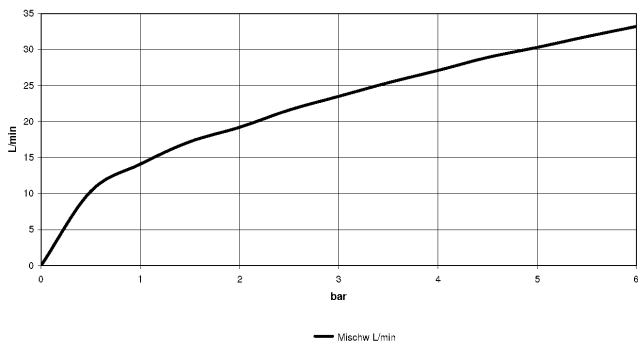

Codes & Standards

ASME
A112.18.1/CSA
B125.1

California Energy
Commission
(CEC)

Bath shower set for bath rim or tile edge installation

27 632 661

Parts for other finishes can be found here: [Brushed Platinum](#)



Spare parts list

No.	Item Number	Name	Quantity used	Delivery time
1	29 300 660-00	Single-lever bath mixer for bath rim or tile edge installation	1	10
2	13 512 661-00	spout	1	10
3	29 140 660-00	Two-way diverter for bath rim or tile edge installation	1	10
4	27 702 660-00	Hand shower set for bath rim or tile edge installation	1	10