

Two-hole bath mixer for free-standing assembly with hand shower set

25 943 360



- 245 mm projection
- spout: rectangular normal flow
- hand shower: normal flow
- hand shower with anti-scale system
- rotary diverter for bath/shower
- wall bracket
- total height 901 mm
- stand pipes height 730 mm
- height up to aerator 610 mm
- slide-on rosettes Ø 90 mm
- gauge 153 mm
- metal shower hose 1250mm with integrated anti-twist protection
- max. flow 51 l/min at 3 bar flow pressure
- max. hand shower flow 6.8 l/min
- WRAS: 1911027







Codes & standards

Intrinsic protection against back flow.

Note: Local building codes may require the use of an anti-scald device. Please refer to remote pressure balance valve (35 910 970 90)

Intrinsic protection against back flow.

Note: Local building codes may require the use of an anti-scald device. Please refer to remote pressure balance valve (35 910 970 90)

	Chrome	25 943 360-00
	Brushed Platinum	25 943 360-06
	Platinum	25 943 360-08
	Durabress (23kt Gold)	25 943 360-09
	Brushed Durabress (23kt Gold)	25 943 360-28
	Brushed Dark Platinum	25 943 360-99

Required miscellaneous

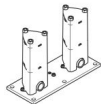

- Concealed floor mounting**
- min. recess depth 80 mm
 - max. recess depth 160 mm

35 951 970-90
0010

Two-hole bath mixer for free-standing assembly with hand shower set

25 943 360

mm [inches]

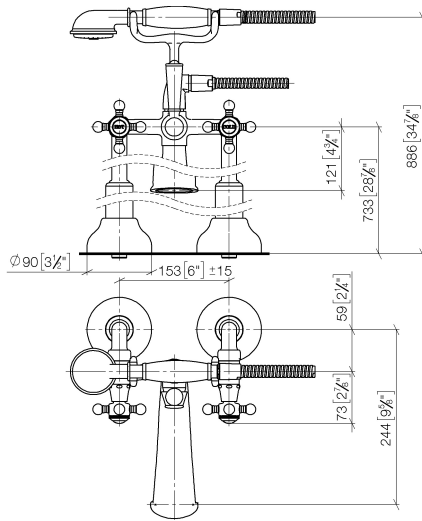

Flow rate chart



Codes & Standards

ASME
A112.18.1/CSA
B125.1

California Energy
Commission
(CEC)

Two-hole bath mixer for free-standing assembly with hand shower set

25 943 360

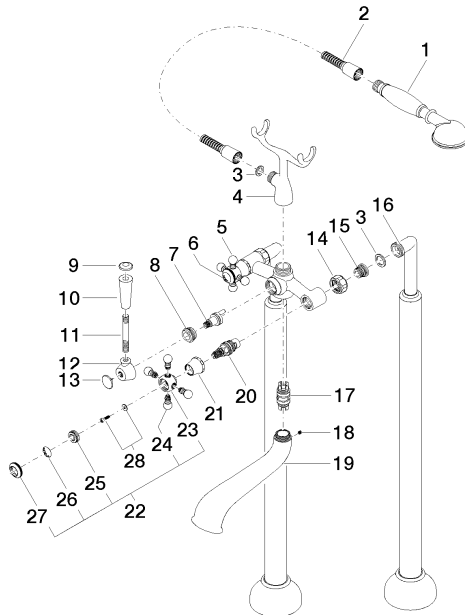



Two-hole bath mixer for free-standing assembly with hand shower set

25 943 360

Spare parts list

No.	Item Number	Name	Quantity used	Delivery time
1	28 002 970-00	Metal hand shower with porcelain insert (white)	1	10
2	28 104 970-00	Metal shower hose 1/2" x 1/2" x 1250 mm	1	2
3	09 14 20 002 90	seal	1	60
4	04 17 20 010 00-00	holder	1	10
5	04 20 36 002 07-00	handle (hot)	1	10
6	09 26 01 011 90	accessories	1	2
7	04 15 01 001 00 90	diverter	1	2
8	09 23 10 007 90	nut	1	2
9	09 30 30 062-00	screw	1	10
10	11 170 370-00	Lever insert	1	10
11	09 28 22 013 90	pipe	1	2
12	09 18 20 011-00	base	1	10
13	09 30 30 064-00	screw	1	10
14	09 23 30 010-00	nut	2	10
15	04 29 05 014 00 90	nipple	2	2
16	12 943 360-00	connection	1	10
17	04 21 10 010 00 90	insert	1	2
18	09 31 11 030 90	pin	1	2
19	13 592 380-00	spout	1	60
20	90 90 03 131 00 90	top	2	2
21	09 21 02 055-00	cover	2	10
22	04 20 36 002 06-00	handle (cold)	1	10
23	09 20 36 002-00	handle	2	10
24	09 20 36 004-00	handle	8	10
25	09 20 83 006 90	handle	2	2
26	09 26 01 010 90	accessories	1	2
27	09 20 36 005-00	handle	2	10
28	04 30 30 029 00 90	fixing set	2	2