

Three-hole basin mixer with pop-up waste

20 713 882



- 165 mm projection
- US pop-up waste (only used in the USA)
- pivotable spout 360°
- circular, air-enriched flow
- height of mixer 285 mm
- height up to aerator 163 mm
- hole diameter valve 32 mm
- hole diameter spout 35 mm
- rosette Ø 55 mm
- 2x screw-in M 10 x 1 pressure hose, leak-tested
- max. flow 4.5 l/min
- lead-free

Codes & standards

- NSF/ANSI 372
- This product can help a building to meet requirements of Green Building Rating Systems, e.g. LEED®, BREEAM®, DGNB, WELL

Only suitable for basins with an overflow.

	Chrome	20 713 882-00 0010
	Brushed Platinum	20 713 882-06 0010
	Platinum	20 713 882-08 0010
	Matte White	20 713 882-10 0010
	Dark Chrome	20 713 882-19 0010
	Brushed Durabronze (23kt Gold)	20 713 882-28 0010
	Matte Black	20 713 882-33 0010
	Brushed Champagne (22kt Gold)	20 713 882-46 0010
	Champagne (22kt Gold)	20 713 882-47 0010
	Brushed Chrome	20 713 882-93 0010
	Brushed Dark Platinum	20 713 882-99 0010



Three-hole basin mixer with pop-up waste

20 713 882

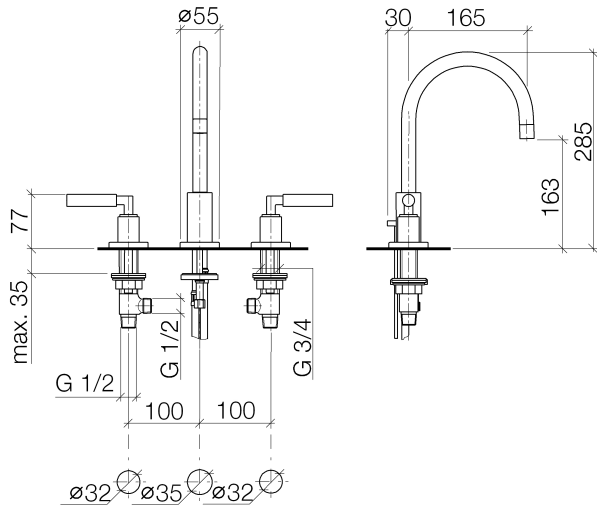

Flow rate chart

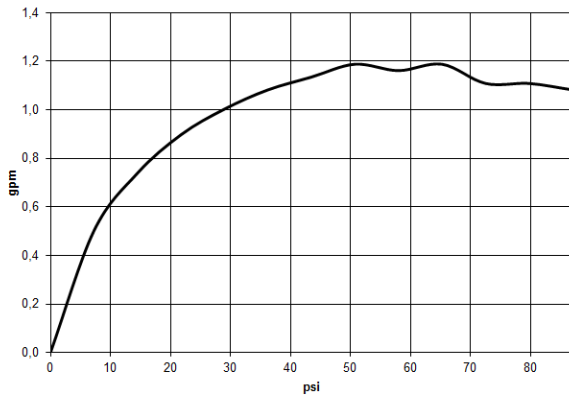

Codes & Standards

ADA

ASME
A112.18.1/CSA
B125.1

California Energy
Commission
(CEC)

NSF/ANSI 372

NSF/ANSI/CAN
61

Three-hole basin mixer with pop-up waste

20 713 882

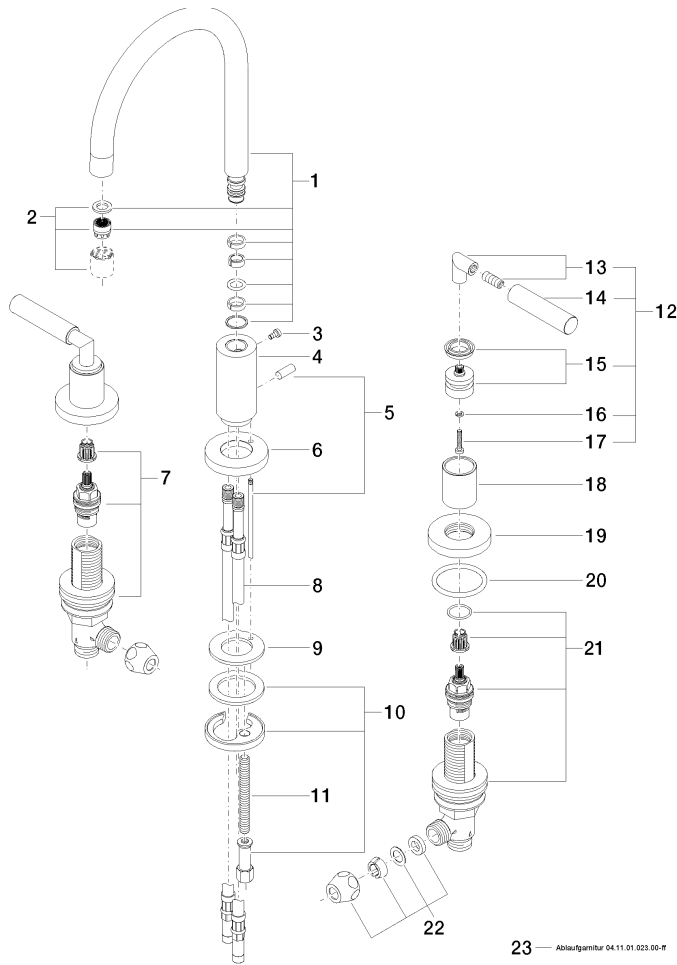

23 — Ablaufsperrtur 04.11.01.023.00-m