







Deck valve clockwise closing hot

20 000 715



- hole diameter 32 mm
- rosette 60 x 60 mm
- with hot marking

Codes & standards

	Chrome	20 000 715-00
	Brushed Platinum	20 000 715-06
	Dark Chrome	20 000 715-19
	Brushed Durabronze (23kt Gold)	20 000 715-28
	Brushed Champagne (22kt Gold)	20 000 715-46
	Champagne (22kt Gold)	20 000 715-47
	Brushed Dark Platinum	20 000 715-99

Deck valve clockwise closing hot

20 000 715

mm [inches]

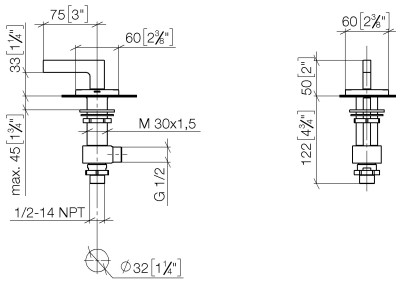

Flow rate chart

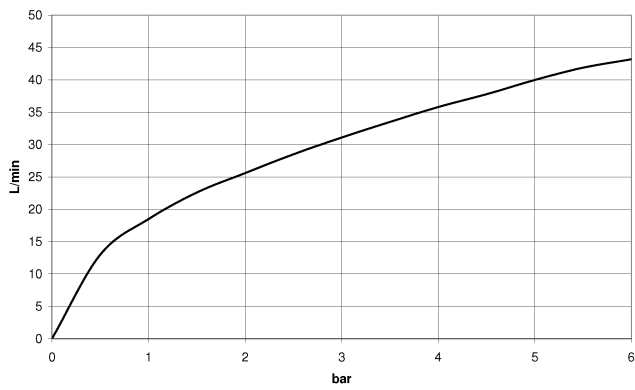

Codes & Standards

ADA

ASME
A112.18.1/CSA
B125.1

Deck valve clockwise closing hot

20 000 715

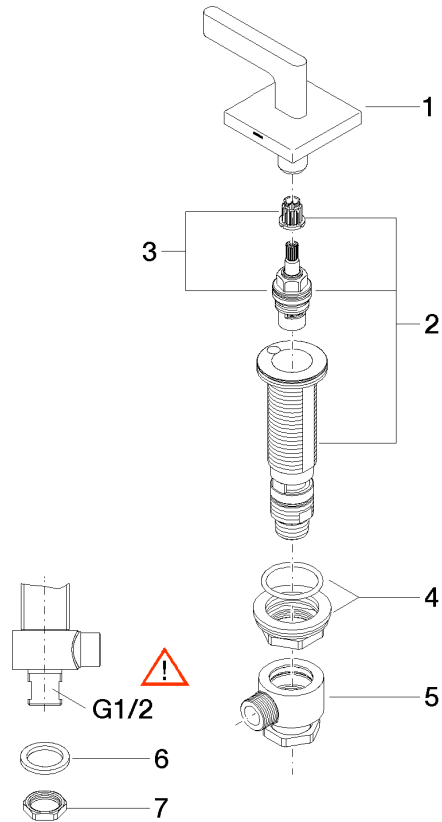

Spare parts list

No.	Item Number	Name	Quantity used	Delivery time
1	90 20 70 057 00-00	handle (hot)	1	10
2	04 17 11 058 33 90	side panel	1	2
3	90 90 03 133 00 90	top	1	2
4	04 23 10 032 78 90	fixing set	1	2
5	04 17 11 023 10 90	distributor	1	2
6	09 30 11 059 90	disc	1	2
7	09 23 10 012 90	nut	1	2