

Wall-mounted basin spout without pop-up waste





13 805 980



- 220 mm projection
- fixed spout
- circular, air-enriched flow
- hole diameter 37 mm
- rosette 60 x 60 mm
- 1/2" connection
- plug-link mounting
- max. flow 4.5 l/min
- lead-free

Codes & standards

- NSF/ANSI 372

	Chrome	13 805 980-00 0010
	Brushed Platinum	13 805 980-06 0010
	Platinum	13 805 980-08 0010
	Brushed Durabronze (23kt Gold)	13 805 980-28 0010
	Brushed Dark Platinum	13 805 980-99 0010

Required miscellaneous

Concealed adapter

35 080 970-90
0010





Wall-mounted basin spout without pop-up waste

13 805 980

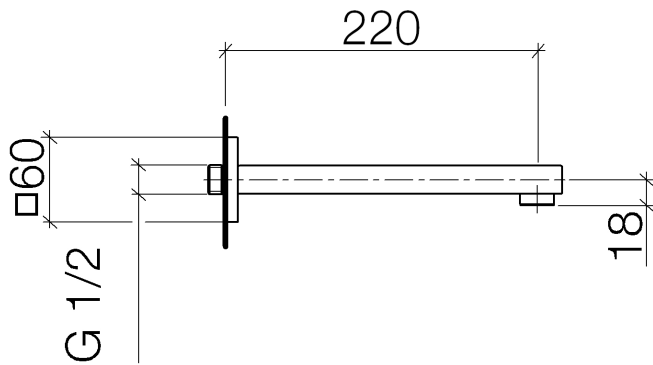

Flow rate chart

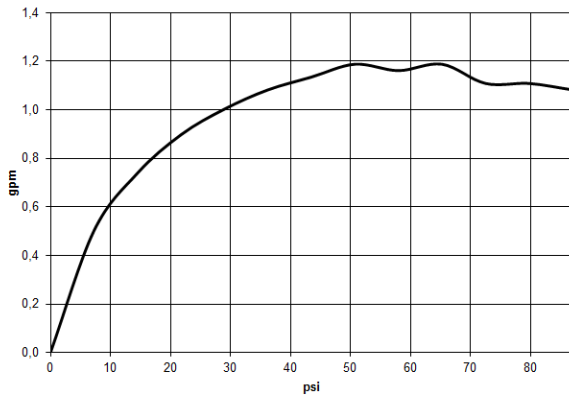

Codes & Standards

ASME
A112.18.1/CSA
B125.1

California Energy
Commission
(CEC)

NSF/ANSI 372

Wall-mounted basin spout without pop-up waste

13 805 980

