

AMERICH®

WHITE SAWYER 7131

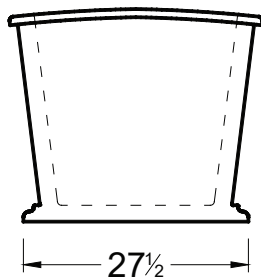
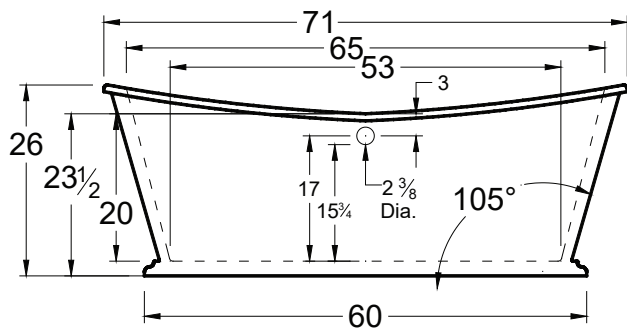
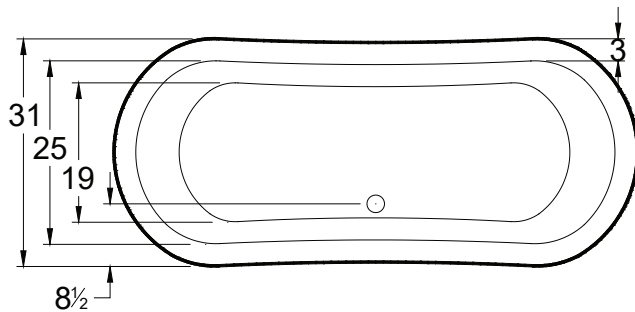

DIMENSIONS

71" x 31" x 26" (1804 x 788 x 661 mm)
Gallon to Overflow = 80 (Liters = 303)

MATERIAL

Acrylic (White Only)

TUB FLOOR

Non-Textured

UNDERMOUNT: No

APPROVALS & COMPLIANCE



Americh products meet or exceed the following standards:

- Underwriters Laboratories (UL)
- Underwriters Laboratories - Canada (cUL)
- Canadian Standards Association - (CSA)
- ANSI Z124.1 • ANSI A112-19.7
- ANSI A112.19.8

Contact Americh for additional approvals.

STANDARD EQUIPMENT

- Integral Waste & Overflow in polished chrome trim
Note: Available with PB, PN, SN, ORB or WH trim at an additional charge if specified at time of order. (Requests after order is shipped are subject to \$75 charge for trim.)

INSTALLATION TIPS

- Install product according to Owners Manual and local codes.
- Hot water supply should be 65-75% of tub capacity or greater. Always consult your local plumber for recommendations as installations will vary.

OPTIONAL ACCESSORIES

- Dual Color
- Pillow: 12"
- Waste & Overflow Upgrades
 - Linear Waste & Overflow

ELECTRICAL REQUIREMENTS

Americh recommends one 20 amp ground fault circuit interrupter (GFCI) for each power supply provided with the bathtub.